

• AXD VERSION •

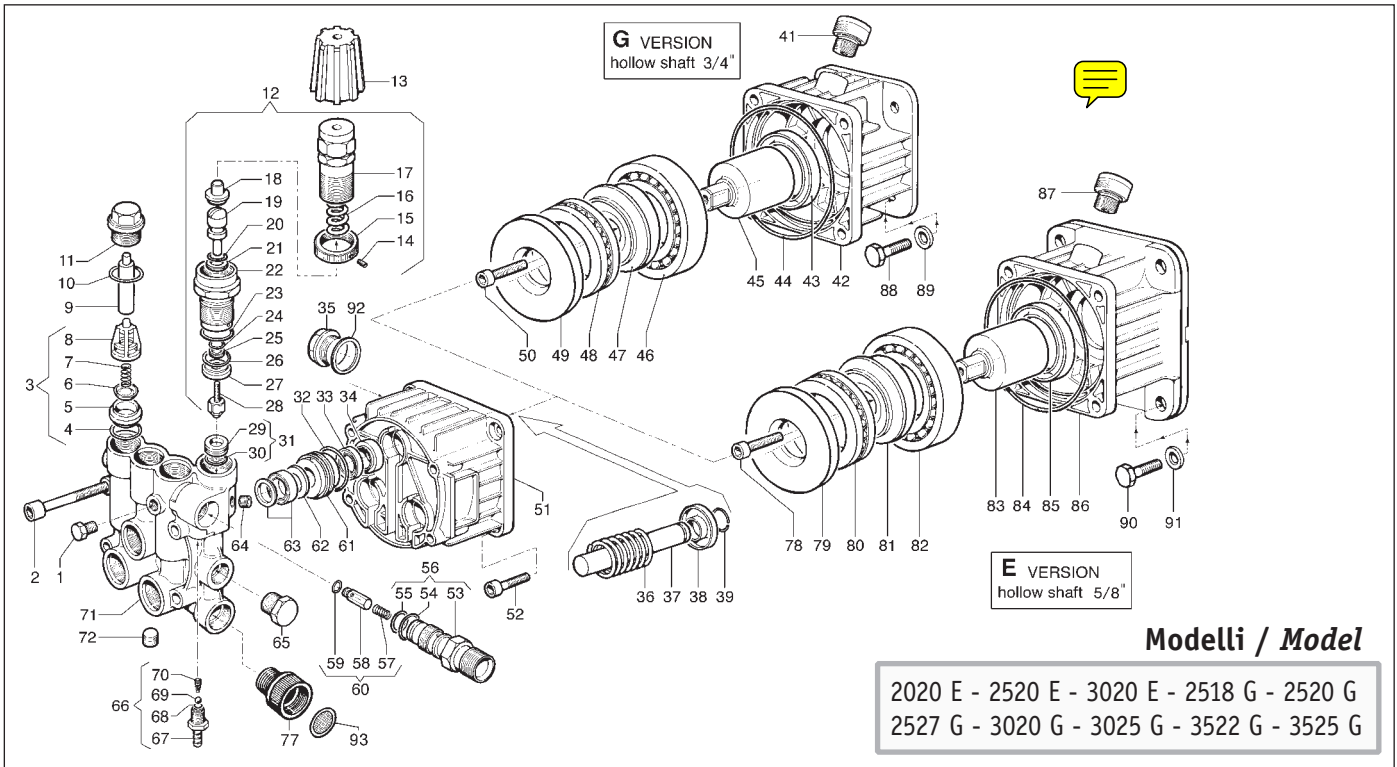

Modelli / Model

2020 E - 2520 E - 3020 E - 2518 G - 2520 G
2527 G - 3020 G - 3025 G - 3522 G - 3525 G

N°	Cod.	Kit	Description	Qty	Note
1	3202 0018		CAP 1/8"	1	
2	3609 0014		SCREW M8X55	4	
3	1220 0045		VALVE KIT	6	
4	1210 0049	A-D	O-RING 1,78X12,42	6	
5	3009 0129	A	VALVE SEAT	6	
6	3604 0028	A	SUC./DEL. VALVE	6	
7	1802 0192	A	SPRING	6	
8	1205 0033	A	VALVE CAGE	6	
9	0601 0273		SPACER	2	
10	1210 0151	A-D	O-RING 1,78X17,17	6	
11	3202 0236		PLUG	6	
12	1215 0271		REG. VAL KIT FOR AX 180 BAR	1	
13	1817 0053		KNOB	1	
14	3622 0030	E	STOP ADJUSTABLE NUT M4X4	1	
15	1227 0022	E	NUT	1	
16	1802 0182	E	SPRING	1	
17	0204 0046	E	ADJUSTABLE KNOB	1	
18	0009 0207	E	SEAT	1	
19	2409 0077	E-F	PISTON ROD	1	
20	1210 0406	E-F	O-RING	1	
21	0009 0206	E-F	RING	1	
22	0204 0045	E	HOUSING	1	
23	1210 0407	E-F	O-RING	1	
24	1210 0405	E-F	O-RING	1	
25	0009 0205	E-F	RING	1	
26	1210 0404	E-F	O-RING	1	
27	0009 0204	E-F	RING	1	
28	3002 0508	E-F	HOUSING WITH BALL	1	
31	3009 0013	E-F	VALVE SEAT	1	
32	1210 0356	B-D	O-RING 1,78X25,12	3	
33	1241 0050	B	PISTON SEAL Ø14	3	2527 G - 3025 G 3525 G
	1241 0057	B	PISTON SEAL Ø14	3	2020 E - 2520 E 3020 E 2518 G - 2520 G 3020 G - 3522 G
34	0019 0103	D	SEALING RING	3	
35	3201 0019		OIL LEVEL PLUG	1	
36	1802 0153		SPRING	3	
37	2409 0089	C	PISTON	3	2020 E - 2520 E 3020 E 2520 G - 2527 G 3020 G - 3025 G 3522 G - 3525 G
	2409 0087			3	2518 G

N°	Cod.	Kit	Description	Qty	Note
38	0009 0221	C	RING	3	
39	0009 0220	C	RING Ø14	3	
51	0403 0135		PUMP CRANKCASE	1	
52	3609 0005		SCREW M8X20	4	
53	3410 0295	E	INJECTOR BODY M22x1,5	1	M22X1,5
	3410 0298	E	INJECTOR BODY 3/8 NPT	1	NPT
54	1210 0040	E-F	O-RING 1,78X 15,6	1	
55	1210 0049	D-E-F	O-RING 1,78X 12,42	1	
56	3410 0302		INJECTOR BODY KIT M22X1,5	1	M22X1,5
	3410 0303		INJECTOR BODY KIT 3/8 NPT	1	NPT
57	1802 0197	E	SPRING	1	
58	2409 0086	E	CHECK VALVE	1	
59	1210 0460	E-F	O-RING	1	
60	2409 0091		CHECK VALVE KIT	1	
61	0009 0219		RING	3	
62	0009 0230	B	RING	3	
63	1241 0055	B	PISTON SEAL 150 BAR	3	2020 E - 2520 E 3020 E 2520 G - 2518 G 3020 G - 3522 G
	1241 0056	B	PISTON SEAL 180 BAR	3	2527 G - 3525 G 3025 G
64	3200 0017		PLUG 1/8X8	1	2020 E - 2520 E 3020 E 2520 G - 2527 G 3020 G - 3025 G 3522 G - 3525 G
	3202 0018		CAP 1/8"	1	2518 G
65	3200 0007		PLUG 3/8 GAS OT58	1	
66	2803 0435		INJECTOR KIT	1	
67	2803 0425		HOSE BARB FITTING	1	
68	2812 0067		O-RING	1	
69	3003 0026		BALL	1	
70	1802 0180		SPRING	1	
71	3218 0299		PUMP VALVE CHAMBER	1	
72	3200 0017		PLUG 1/8X8	1	2020 E - 2520 E 3020 E 2520 G - 2527 G 3020 G - 3025 G 3522 G - 3525 G
	3202 0018		CAP 1/8"	1	2518 G
77	2800 0096		GARDEN HOSE TAIL	1	only NPT
92	1210 0048		O-RING Ø2,62x20,24	1	
93	1002 0116			1	solo / only NPT

• AXD VERSION •

Versione E (Albero femmina 5/8") E Version (Hollow Shaft 5/8")

N°	Cod.	Kit	Description	Qty	Note
78	3609 0005		SCREW M8X20	1	
79	2816 0025		THRUST BEARING	1	
80	0436 0016		AXIAL BEARING	1	
81	0001 0431		ECCENTRIC SHAFT 6°	1	2020 E
	0001 0417		ECCENTRIC SHAFT 8°	1	2520 E
	0001 0419		ECCENTRIC SHAFT 9°	1	3020 E
82	0438 0076		BALL BEARING 40X80X18 mm	1	
83	0001 0422		HOLLOW SHAFT 5/8"	1	
84	1210 0429	D	O-RING	1	
85	0019 0034	D	SEALING RING 40X55X7	1	
86	3002 0538		SUPPORT	1	
87	3200 0071		PLUG G3/8	1	
90	3607 0168		SCREW 3/8" 16UNC x 1"	4	
91	2811 0002		WASHER 10,5X20X2 mm	4	

Versione G (Albero femmina 3/4") G Version (Hollow Shaft 3/4")

N°	Cod.	Kit	Description	Qty	Note
41	3200 0071		PLUG G3/8	1	
42	3002 0522		SUPPORT	1	
43	0019 0034	D	SEALING RING 40X55X7	1	
44	1210 0429	D	O-RING	1	
45	0001 0395		HOLLOW SHAFT 3/4"	1	
46	0438 0076		BALL BEARING 40X80X18 mm	1	
47	0001 0417		ECCENTRIC SHAFT 8°	1	2527 G 2520 G (M22X1,5)
	0001 0418		ECCENTRIC SHAFT 8°30'	1	3020 G
	0001 0419		ECCENTRIC SHAFT 9°	1	3025 G
	0001 0420		ECCENTRIC SHAFT 10°30'	1	3522 G - 3525 G
	0001 0425		ECCENTRIC SHAFT 7°30'	1	2520 G (NPT) 2518 G
48	0436 0016		AXIAL BEARING	1	
49	2816 0025		THRUST BEARING	1	
50	3609 0005		SCREW M8X20	1	
88	3607 0119		SCREW 5/16" 24UNF x 1"	4	
89	2811 0004		WASHER 8,4X14X1,6 mm	4	

Kit Valvola Aspirazione/Mandata (5025 0014) Complete Valve Kit

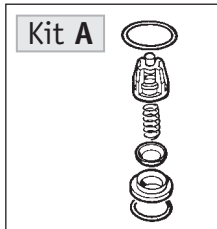

5025 0014		
N°	Cod.	Qty
4	1210 0049	6
5	3009 0129	6
6	3604 0028	6
7	1802 0192	6
8	1205 0033	6
10	1210 0151	6

Kit Revisione • Overhaul Kit M22 x 1,5 (5026 0142) - 3/8" NPT (5026 0143)

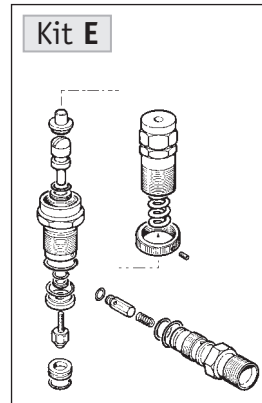

5026 0142			5026 0143		
N°	Cod.	Qty	N°	Cod.	Qty
14	3622 0030	1	14	3622 0030	1
15	1227 0022	1	15	1227 0022	1
16	1802 0182	1	16	1802 0182	1
17	0204 0046	1	17	0204 0046	1
18	0009 0207	1	18	0009 0207	1
19	2409 0077	1	19	2409 0077	1
20	1210 0406	1	20	1210 0406	1
21	0009 0206	1	21	0009 0206	1
22	0204 0045	1	22	0204 0045	1
23	1210 0407	1	23	1210 0407	1
24	1210 0405	1	24	1210 0405	1
25	0009 0205	1	25	0009 0205	1
26	1210 0404	1	26	1210 0404	1
27	0009 0204	1	27	0009 0204	1
28	3002 0508	1	28	3002 0508	1
31	3009 0013	1	31	3009 0013	1
53	3410 0295	1	53	3410 0298	1
54	1210 0040	1	54	1210 0040	1
55	1210 0049	1	55	1210 0049	1
57	1802 0197	1	57	1802 0197	1
58	2409 0086	1	58	2409 0086	1
59	1210 0460	1	59	1210 0460	1

Kit Guarnizioni Pistoni • Piston Seal Kit 150 bar (5019 0077) - 180 bar (5019 0078)

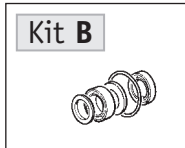

5019 0077			5019 0078		
N°	Cod.	Qty	N°	Cod.	Qty
32	1210 0356	3	32	1210 0356	3
33	1241 0057	3	33	1241 0050	3
62	0009 0230	3	62	0009 0230	3
63	1241 0055	3	63	1241 0056	3

Kit Pistone Ø14 mm • Ø14 mm Piston Kit (2409 0092)

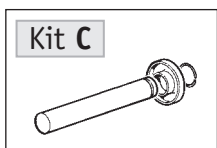

2409 0092		
N°	Cod.	Qty
37	2409 0089	3
38	0009 0221	3
39	0009 0220	3

Kit Guarnizioni Pompa • Seal Kit (5019 0079)

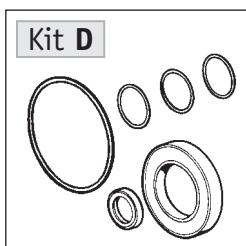

5019 0079		
N°	Cod.	Qty
4	1210 0049	6
10	1210 0151	6
32	1210 0356	3
34	0019 0103	3
43	0019 0034	1
44	1210 0429	1
55	1210 0049	1

Kit manutenzione • Maintenance Kit (5026 0144)

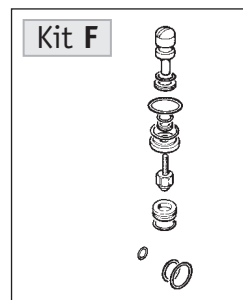

5026 0144		
N°	Cod.	Qty
19	2409 0077	1
20	1210 0406	1
21	0009 0206	1
23	1210 0407	1
24	1210 0405	1
25	0009 0205	1
26	1210 0404	1
27	0009 0204	1
28	3002 0508	1
31	3009 0013	1
54	1210 0040	1
55	1210 0049	1
59	1210 0460	1

Altri KIT • Other KIT → vedi pagine • see page : 55