



# Model K 1400 Part No. 1.421-205.0

## High Pressure Washer Operator Manual

Overview	1
Precautions	1-3
Assembly Instructions	3-4
Operating Instructions	4-5
GFCI Instructions	5
Using the Accessories	5
Working with Detergents	6
Shut Down and Clean-Up	7
Taking a Break	7
Winterizing and Long-Term Storage	7
Maintenance Instructions	8
Cleaning Tips	8-9
Optional Cleaning Accessories	9
Troubleshooting	10-11

### Specifications

Operating pressure 1400 PSI  
Water volume 1.3 GPM  
Voltage 120 V  
Amp draw 14 AMPS

**In USA Call:**  
**1-800-537-4129**  
or visit our website:  
[www.karcher-usa.com](http://www.karcher-usa.com)



## Model K 1400 OVERVIEW

### Item Description

1. Power cord with Ground Fault Circuit Interrupter (GFCI)
2. Trigger gun
3. Trigger gun safety lock
4. High pressure hose
5. Water inlet with filter and garden hose connector
6. Retractable handle
7. Power cord holder (not pictured)
8. Detergent suction tube with filter
9. High pressure outlet
10. On/Off switch
11. Spray wand extension (must be used for attaching accessories)
12. Wash brush
13. Quattro-nozzle
14. Concentrated power cleaning tabs-sampler

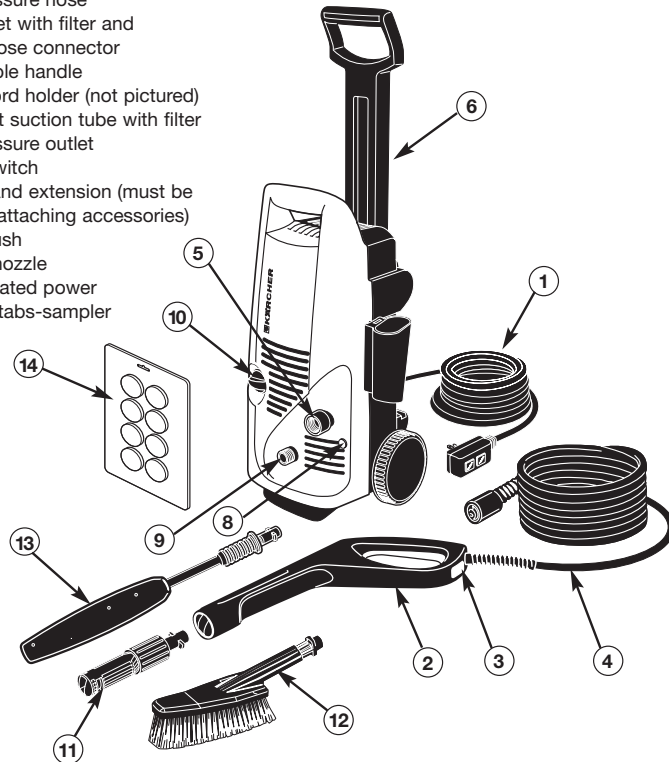

## NEVER!

- Never** point nozzle at people or animals.
- Never** drink alcohol or use drugs while operating this equipment.
- Never** operate while standing in water.
- Never** touch plug with wet hands.
- Never** let electrical connections rest in water.
- Never** operate pressure washer without the water turned on.
- Never** use hot water.

## IMPORTANT PRECAUTIONS – Read First!

### ⚠ Safety Warnings

When using this product, basic precautions should always be followed:

- Read all the instructions before using the product.
- High pressure jets can be dangerous if subject to misuse. The jet must not be directed at persons, animals, electrical devices, or the machine itself.
- To reduce the risk of injury, do not operate the machine near children.
- Learn how to stop the machine and release pressure quickly. Be thoroughly familiar with the controls.
- Stay alert — watch what you are doing.
- Wear safety goggles. 
- Do not use acids, solvents, or any flammable material in this product. These products can cause physical injuries to the operator and irreversible damage to the machine.
- Do not operate the product when fatigued or under the influence of alcohol or drugs.
- Keep operating area clear of all persons.
- Do not stand on unstable surfaces. Stand with both feet balanced at all times.
- To reduce the risk of electrocution, keep all connections dry and off the ground. Do not touch plug with wet hands.
- The Gun Safety Lock PREVENTS the trigger from accidentally being engaged. This safety feature DOES NOT lock trigger in the on position.

### Extension Cords

Use a sufficient gauge: Up to 25 ft = 12/3 AWG; 25 to 50 ft = 10/3 AWG. Use only extension cords that are intended for outdoor use. These extension cords are identified by the marking "Acceptable for use with outdoor appliances; store indoors while not in use." Use only extension cords having an electrical rating not less than the rating of the product. Do not use damaged extension cords. Examine extension cord before using and replace if damaged. Do not abuse extension cord

and do not yank on any cord to disconnect. Keep cord away from heat and sharp edges. Always disconnect the extension cord from the receptacle before disconnecting the product from the extension cord. If you are using an extension cord, it should always be completely unwound from the cable drum.

### Ground Fault Circuit Interrupter (GFCI) Protection

This product is supplied with a Ground Fault Circuit Interrupter (GFCI) built into the power cord plug. This device provides additional protection from the risk of electric shock. If power is interrupted in the line, the GFCI will automatically re-close the circuit to the load after power is restored. Depending on the GFCI model, it may be necessary to manually operate the reset button to restore power to the GFCI load circuit. If replacement of the plug or cord is needed use identical replacement parts.

### This Product Is Double Insulated

In a double-insulated product, two systems of insulation are provided instead of grounding. No grounding method is provided on a double-insulated product, nor should a method for grounding be added to the product. Servicing a double-insulated product requires extreme care and knowledge of the system, and should be done only by qualified service personnel. Replacement parts for a double-insulated product must be identical to the parts they replace. A double-insulated product is marked with the words, "DOUBLE INSULATED."

### ⚠ Caution

- Follow the maintenance instructions specified in the manual.
- This machine has been designed for use with cleaning detergent supplied or recommended by the manufacturer. The use of other cleaning detergents may affect the operation of the machine and void the warranty.

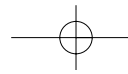

## IMPORTANT PRECAUTIONS – continued

### Water Supply (Cold Water Only)

- Water hose must be at least 3/4 inch in diameter.
  - Flow rate of water supply must not fall below 2.5 GPM (gallons per minute).
  - Flow rate can be determined by running the water for one minute into an empty 5-gallon container.
  - The water supply temperature must not exceed 104°F/40°C.
  - Never use the pressure washer to draw in water contaminated with solvents, e.g. paint thinners, gasoline, oil, etc.
  - Always prevent debris from being drawn into the unit by using a clean water source.
- **Save these instructions!**

## ASSEMBLY INSTRUCTIONS

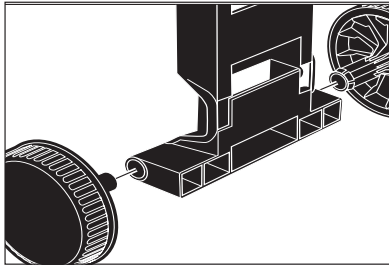

3

**Step 1** Insert wheels into side holes at the bottom of the pressure washer and snap into place.

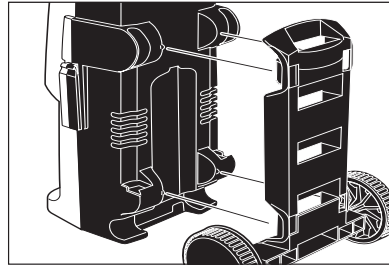

**Step 2** Place the wheel carriage onto the mounting brackets on the sides of the washer and align the four holes. Snap into place.

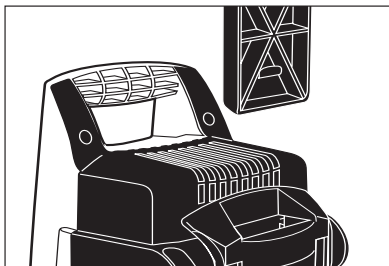

**Step 3** Slide the handle into the top slot of the wheel carriage and snap into place.

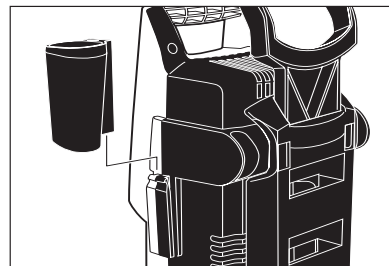

**Step 4** Slide the trigger gun holder into track on the right hand side of the pressure washer.

## ASSEMBLY INSTRUCTIONS – continued

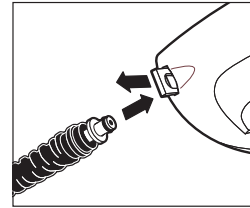

**Step 5** Pull out the locking slide from the right side of the trigger gun handle, and insert the small end of the high pressure hose into place. Push the locking slide back into the trigger gun to lock the hose in position.

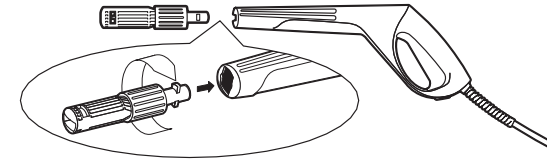

**Step 6** Insert the Spray Wand Extension into the trigger gun. Press in against the spring tension and twist into the lock position. Turn the Spray Wand Extension Collar clockwise until tight. **Note: spray wand extension must be attached to use accessories.**



**Step 7** Attach quattro nozzle for four different spray settings.

## OPERATING INSTRUCTIONS

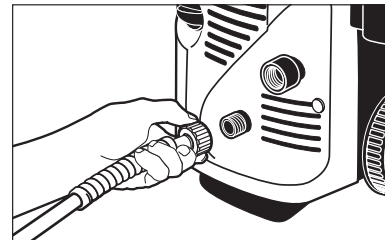

**Step 1** Connect the high pressure hose to the high pressure outlet.

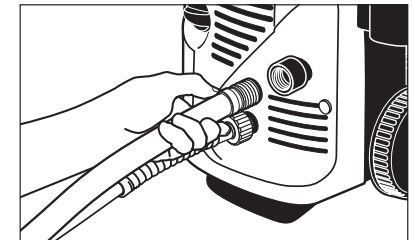

**Step 2** Connect the garden hose to the water inlet.

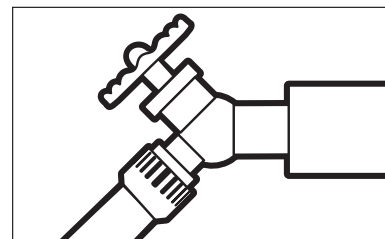

**Step 3** Connect garden hose to the cold water source and turn water on completely.

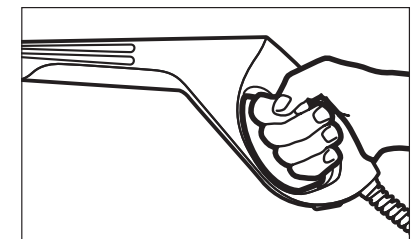

**Step 4** Plug the power cord into the power outlet. Trigger the gun to eliminate trapped air, wait for a steady flow of water to emerge from the spray nozzle.

4

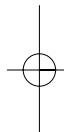

## OPERATING INSTRUCTIONS – continued

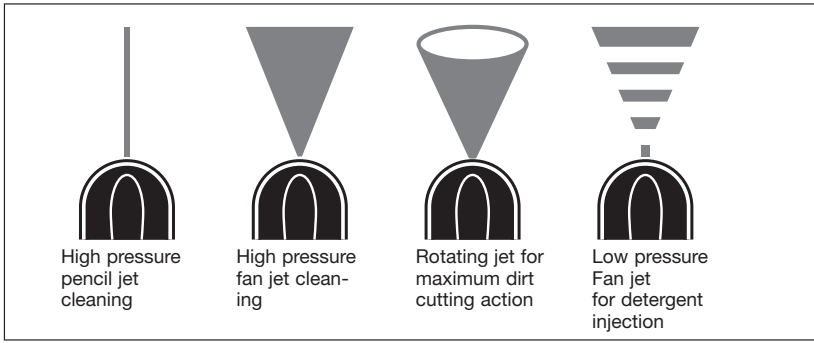

**Step 5** Turn Quattro Nozzle to desired setting position. Match symbols above.

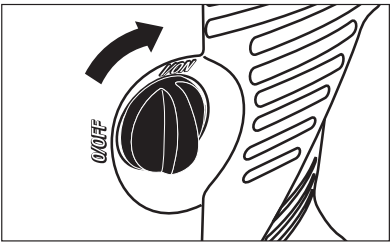

**Step 6** Turn on the pressure washer. The motor starts only if the trigger of the gun is pulled and shuts off when the trigger is released.

**! WARNING**  
**RISK OF INJECTION OR INJURY- DO NOT DIRECT DISCHARGE STREAM AT PERSONS. TO AVOID SERIOUS INJURY, NEVER POINT SPRAY NOZZLE AT YOURSELF, OTHER PERSONS OR ANIMALS.**

## GFCI INSTRUCTIONS

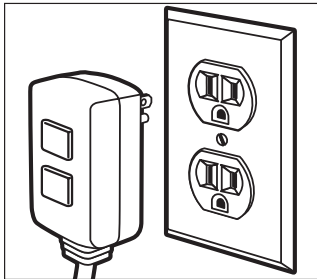

**Step 1** Plug the Ground Fault Circuit Interrupter (GFCI) into a working outlet.

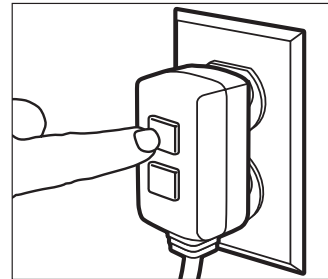

**Step 2** Press "TEST", then press "RESET" to assure proper connection to power.

**Note:** The actual appearance of the GFCI may be different from this illustration.

## WORKING WITH DETERGENTS

Detergents can only be applied at low pressure (-).

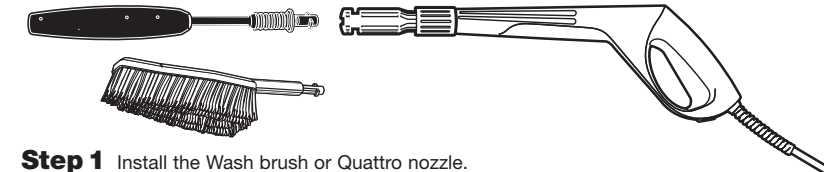

**Step 1** Install the Wash brush or Quattro nozzle.

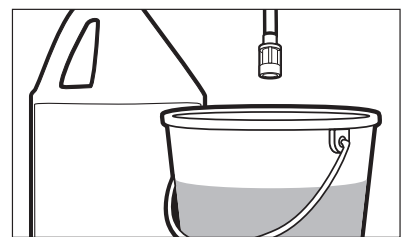

**Step 2** Fill a container with Kärcher detergent. Place the filter end of detergent suction tube into the container.

**For best results see Cleaning Tips on pages 8 & 9 or included cleaning guide for specific information on how to clean different surfaces. Always Use Kärcher Detergents for Best Results.**

Kärcher biodegradable detergents are specially formulated to protect the environment and your pressure washer. The special formula won't clog the suction tube filter and will protect the internal parts of the pressure washer for a longer life. For Kärcher Detergents, check your retailer or call:

**In USA Call:**  
**1-800-537-4129**  
 or visit our website:  
[www.karcher-usa.com](http://www.karcher-usa.com)

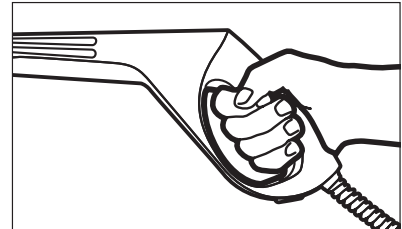

**Step 3** Turn on the pressure washer. Pull trigger to operate unit: Liquid detergent is drawn into the unit and mixed with water. Apply detergent to work area. Do not allow detergent to dry on surface.

**The following Kärcher detergents are available:**

LIQUIDS (ready to use)	TABLETS (concentrated)
Vehicle Wash	All Purpose
House Wash	Degreaser
Degreaser	Deck and Patio
Deck Wash	Windows and Siding
All Purpose Cleaner	
Vehicle Wax	

**! Caution**  
**Never use:**

- Bleach, Chlorine products and other corrosive chemicals
- Liquids containing solvents (i.e., paint thinners, gasoline, oils)
- Tri-sodium phosphate products
- Ammonia products
- Acid-based products

**These chemicals will harm the unit and will damage the surface being cleaned.**

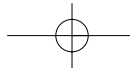

## SHUTTING DOWN & CLEAN-UP

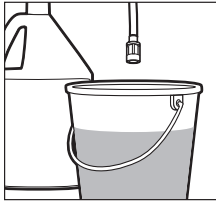

**Step 1** Remove detergent suction tube from container and insert into 1 gallon of fresh water. Siphon water at low pressure for one minute.

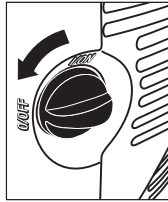

**Step 2** Turn the switch to off (O) position and unplug cord from outlet.

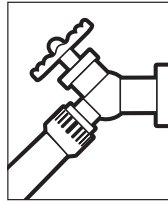

**Step 3** Turn off the water source.



**Step 4** Press trigger to release water pressure.

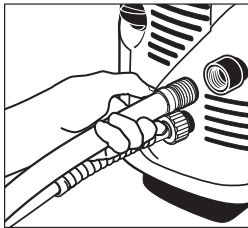

**Step 5** Disconnect the garden hose from the water inlet on the unit.

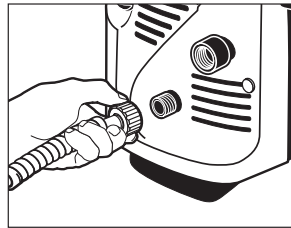

**Step 6** Disconnect the high pressure hose from the high pressure outlet.

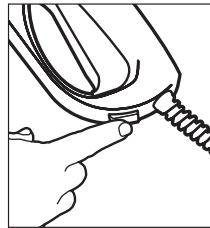

**Step 7** Engage the gun safety lock.

7

## TAKING A BREAK... five minutes or more

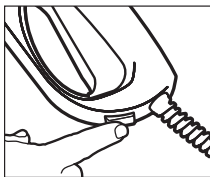

**Step 1** Engage gun safety lock.

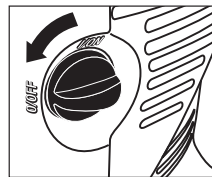

**Step 2** Turn pressure washer to off (O) position.

## WINTERIZING AND LONG-TERM STORAGE

1. Disconnect all water connections.
2. Start the machine for a **few seconds**, until the water which had remained in the pump exits. Turn off immediately.
3. Do not allow high pressure hose to become kinked.

4. Store the machine and accessories in a room which does not reach freezing temperatures.

**Caution: Failure to follow the above directions will result in damage to the pump assembly and accessories.**

## MAINTENANCE INSTRUCTIONS

This unit is maintenance free.

## CLEANING TIPS

### Deck Cleaning

(with or without detergent)

Pre-rinse deck and surrounding area with fresh water. If using Kärcher Deck and Patio Cleaner, place detergent suction tube directly into cleaning solution and apply to surface at low pressure. For best results, limit your work area to smaller sections of approximately 25 square feet. Allow Kärcher Deck and Patio Cleaner to remain on surface 1-3 minutes. Do not allow detergent to dry on surface. Rinse at high pressure in a long sweeping motion keeping the spray nozzle approximately 3-6 inches from the cleaning surface. Always clean from top to bottom and from left to right. When moving on to a new section of the cleaning surface, be sure to overlap the previous section to eliminate stop marks and ensure a more even cleaning result.

### Cement Patios, Brick and Stone

(with or without detergent)

Pre-rinse cleaning surface with fresh water. If using Kärcher Deck and Patio or All Purpose Cleaner, place detergent suction tube directly into cleaning solution and apply to surface at low pressure. For best results, limit your work area to smaller sections of approximately 25 square feet. Allow Kärcher Deck and Patio or All Purpose Cleaner to remain on surface 1-3 minutes. Do not allow detergent to dry on surface. Rinse at high pressure in a sweeping motion keeping the spray nozzle approximately 3-6 inches from the cleaning surface. Always clean from top to bottom and from left to right.

### Cars, Boats & Motorcycles

(with or without detergent)

Pre-rinse vehicle with fresh water. If using Kärcher Vehicle or All Purpose Cleaner, place detergent suction tube directly into cleaning solution and apply to surface at low pressure. For best results, clean one side of vehicle at a time and always apply detergent from bottom to top, do not allow detergent to dry on surface. If needed, use special Wash Brush Attachment to remove stubborn dirt. Rinse at high pressure in a sweeping motion keeping the spray nozzle approximately 6-8 inches from the cleaning surface (distance should increase when rinsing pin-striping or other sensitive surfaces). Always clean from top to bottom and from left to right. For best results, wipe surface dry with a chamois or soft dry cloth.

8

### House Siding

(with or without detergent)

Pre-rinse cleaning surface with fresh water. If using Kärcher House or Window and Siding Cleaner, place detergent suction tube directly into cleaning solution and apply to surface at low pressure (for best results, limit your work area to sections of approximately 6 feet and always apply detergent from bottom to top). Allow Kärcher House or Window and Siding Cleaner to remain on surface 1-3 minutes. Do not allow detergent to dry on surface, if surface appears to be drying, simply wet down surface with fresh water. If needed, use special Wash Brush Attachment to remove stubborn dirt. Rinse at high pressure from top to bottom in an even sweeping motion keeping the spray nozzle approximately 6 inches from the cleaning surface.



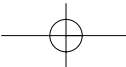

**CLEANING TIPS – continued**

**Barbecue Grills, Outdoor Power Equipment & Gardening Tools (with or without detergent)**

Pre-rinse cleaning surface with fresh water. If using Kärcher All Purpose Cleaner or Degreaser, place detergent suction tube directly into cleaning solution and apply detergent at low pressure. Allow Kärcher detergent to remain on surface 1-3 minutes. Do not allow detergent to dry on surface. Rinse at high pressure keeping the spray nozzle approximately 3-6 inches from the cleaning surface. For removing extremely stubborn dirt, it may be necessary to move the spray nozzle even closer to the surface for greater dirt cutting action. To remove caked on mud from garbage cans, lawn mower blades, wheel barrels or other non-sensitive metal surfaces, you may want to experiment with different settings on the Quattro Nozzle.

**Patio & Lawn Furniture (with or without detergent)**

Pre-rinse furniture and surrounding area with fresh water. If using Kärcher All Purpose Cleaner, place detergent suction tube directly into cleaning solution and apply to surface at low pressure. Allow Kärcher All Purpose Cleaner to remain on surface 1-3 minutes. Do not allow detergent to dry on surface. If needed use special Wash Brush Attachment to remove stubborn dirt. Rinse at high pressure in a sweeping motion keeping the spray nozzle approximately 3-6 inches from the cleaning surface. For best results, clean from top to bottom and from left to right.

**Recommendations**

- Before cleaning any surface an inconspicuous area should be cleaned to test spray pattern and distance for maximum cleaning results.
- If painted surfaces are peeling or chipping, use extreme caution as pressure washer may remove the loose paint from the surface.
- While using on surfaces which might come in contact with food. Flush surfaces with plenty of drinking water.

**OPTIONAL CLEANING ACCESSORIES**

Optional cleaning accessories are available to further enhance your cleaning capabilities: See accessories order form for product descriptions and ordering instructions.

- Vario Spray Wand
- House Washing Wand
- Extension Wand
- Flexible Spray Wand
- Underbody Spray Wand
- 4 Piece Extension Wand
- Wet Sandblasting Attachment
- Pipe Drain Cleaner
- Water Suction Hose With Filter
- Extension Hose 25'
- Rotating Wash Brush
- K12 Surface Cleaner

**In USA Call:  
1-800-537-4129  
or visit our website: [www.karcher-usa.com](http://www.karcher-usa.com)**

**TROUBLESHOOTING**

Disconnect the machine from the power source before making any repair.

Symptom	Cause	Solution
<b>Motor will not start.</b>	On/Off switch is in the "OFF" (O) position.	Turn switch to the "ON" (I) position.
	Power cord is not plugged in.	Plug in power cord.
	Extension cord is too long. Extension cord is not proper gauge. Extension cord is damaged.	Replace extension cord with either a 25 ft. 12/3 gauge cord or a 50 ft. 10/3 gauge cord.
	Electrical outlet does not supply adequate power.	Try a different outlet.
	Ground Fault Circuit Interrupter (GFCI) tripped.	Reset breaker (power supply) or GFCI.
<b>Unit does not reach high pressure.</b>	Diameter of garden hose is too small.	Replace with a 3/4 inch garden hose.
	Water supply is restricted.	Check garden hose for kinks, leaks and blockage.
	Not enough inlet water supply.	Open water source full force.
	Water inlet filter is clogged.	Remove filter and rinse out in warm water.
	Quattro Nozzle is in low pressure position.	Turn Quattro Nozzle to high pressure position.
	Wash brush is attached.	Attach Quattro Nozzle.
<b>Output pressure varies high and low.</b>	Not enough inlet water supply.	Turn water on full force. Check garden hose for kinks, leaks or blockage.
	Pump is sucking air.	Check that hoses and fittings are air tight. Turn off machine and purge pump by squeezing trigger gun until a steady flow of water emerges through the nozzle.
	Water inlet filter is clogged.	Remove filter and rinse out in warm water.
	Discharge nozzle is obstructed.	Blow out or remove debris with a fine needle.
	Calcified gun, hose or Quattro Nozzle.	Run distilled vinegar through detergent suction tube.

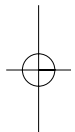

**TROUBLESHOOTING – continued**

Symptom	Cause	Solution
<b>No detergent.</b>	Detergent suction tube not properly connected to the machine.	Check connection.
	Detergent is too thick.	Dilute detergent, for best results use Kärcher detergent.
	Filter on detergent suction tube is clogged.	Run warm water through filter to remove debris.
	Damaged or clogged detergent suction tube.	Remove obstruction or replace detergent suction tube.
	Quattro Nozzle is in high pressure position.	Turn Quattro Nozzle to low pressure position.
	Discharge nozzle is obstructed.	Blow out or remove debris with fine needle.
	Detergent container is empty.	Add more detergent.
<b>Garden hose connection leaks.</b>	Loose fittings.	Tighten fittings.
	Missing/worn rubber washer.	Insert new washer.
<b>Quattro Nozzle or accessory leaks.</b>	Quattro Nozzle not properly attached.	Insert the Quattro Nozzle into an accessory of your choice. Push in and turn clockwise to lock Quattro Nozzle in place.
	Spray wand extension not properly attached.	Insert the spray wand extension into the trigger gun. Press in against the spring tension and twist into the lock position. Turn the spray wand extension collar clockwise until tight.
	Broken o-ring.	Call Kärcher customer service hotline and order an o-ring.
<b>Pump is noisy.</b>	Pump is sucking air.	Check that hoses and fittings are air tight. Turn off machine and purge pump by squeezing trigger gun until a steady flow of water emerges through the nozzle.
<b>Water leaks from pump.</b>	Loose fittings.	Check that all fittings are tight.
	Water seals are damaged or worn.	Call service center.
<b>Oil Drip.</b>	Oil seals are damaged or worn.	Call service center.

11

In USA Call:  
**1-800-537-4129**  
 or visit our website: [www.karcher-usa.com](http://www.karcher-usa.com)

If you encounter any additional difficulties not listed, please call our service center for help.

**Kärcher Customer Support USA**