

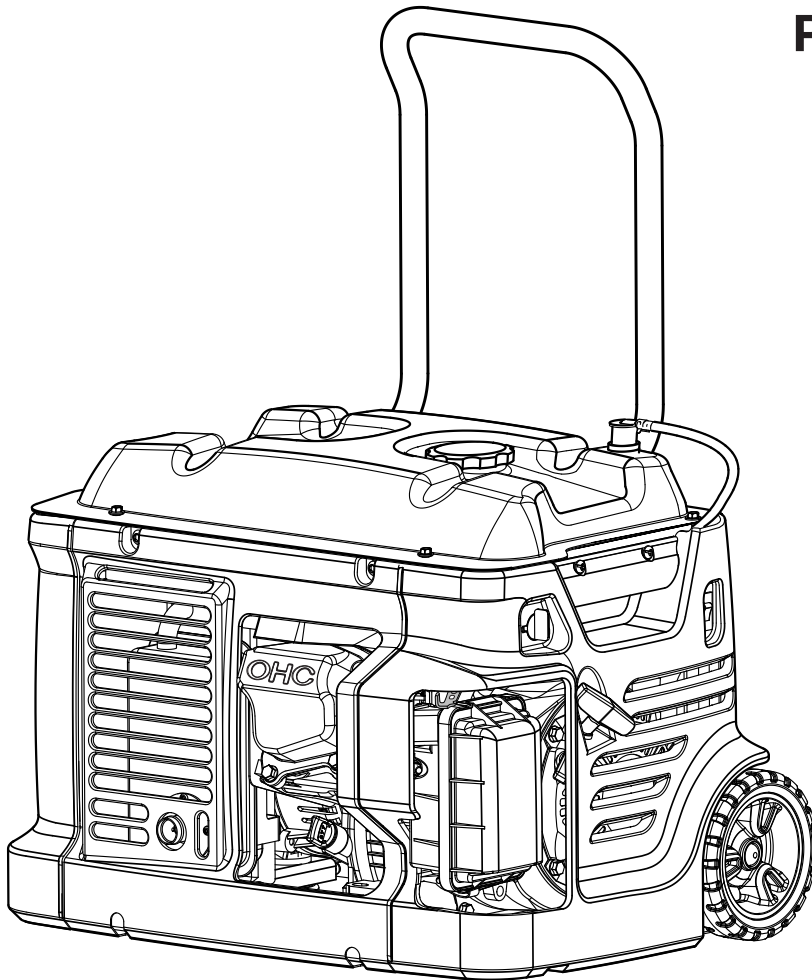

OPERATOR'S MANUAL MANUAL DEL OPERADOR

PORTABLE GENERATOR GENERADOR PORTÁTIL

HU22511



NEUTRAL BONDED TO FRAME
PUNTO NEUTRO CONECTADO AL MARCO

To register your HUSKY product,
please visit:
<http://register.huskyoutdoortools.com/>
Para registrar su producto de HUSKY,
por favor visita:
<http://register.huskyoutdoortools.com/>

Your generator has been engineered and manufactured to our high standard for dependability, ease of operation, and operator safety. When properly cared for, it will give you years of rugged, trouble-free performance.

⚠ DANGER: You WILL be KILLED or SERIOUSLY HURT if you do not follow the instructions in this operator's manual.

Thank you for your purchase.

SAVE THIS MANUAL FOR FUTURE REFERENCE

Su nuevo generador ha sido diseñado y fabricado de conformidad con estrictas normas para brindar fiabilidad, facilidad de uso y seguridad para el operador. Con el debido cuidado, le brindará muchos años de sólido y eficiente funcionamiento.

⚠ PELIGRO: El incumplimiento de las instrucciones en este manual del operador puede CAUSARLE LA MUERTE O LESIONARLE GRAVEMENTE.

Le agradecemos su compra.

GUARDE ESTE MANUAL PARA FUTURAS CONSULTAS

TABLE OF CONTENTS

■ Introduction.....	2
■ Important Safety Instructions.....	3-4
■ Specific Safety Rules.....	4
■ Symbols.....	5-7
■ Electrical.....	8-9
■ Features.....	10
■ Assembly.....	11
■ Operation.....	12-13
■ Maintenance.....	14-16
■ Troubleshooting.....	17
■ Warranty.....	18-19
■ Parts Ordering / Service.....	Back Page

INTRODUCTION

This product has many features for making its use more pleasant and enjoyable. Safety, performance, and dependability have been given top priority in the design of this product, making it easy to maintain and operate.

DANGER:

GROUNDING THE GENERATOR

To reduce the risk of shock or electrocution, generator must be properly grounded. The nut and ground terminal on the frame must always be used to connect the generator to a suitable ground source. The ground path should be made with #8 size wire. Connect the terminal of the ground wire between the lock washer and the nut, and tighten the nut fully. Connect the other end of the wire securely to a suitable ground source.

The National Electric Code contains several practical ways in which to establish a good ground source. If a steel or iron rod is used, it should be at least 5/8 in. diameter, and if a nonferrous rod is used, it should be at least 1/2 in. diameter and be listed as material for grounding. Drive the rod or pipe to a depth of 8 ft. If a rock bottom is encountered less than 4 ft. down, bury the rod or pipe in a trench.

All electrical tools and appliances operated from this generator must be properly grounded by use of a third wire or be "Double Insulated."

It is recommended to:

1. Use electrical devices with 3-prong grounded plugs.
2. Use an extension cord with a 3-pole receptacle and a 3-prong plug at opposite ends to ensure continuity of the ground protection from the generator to the appliance.

Check and adhere to all applicable federal, state, and local regulations relating to grounding specifications. Consult a qualified electrician or service personnel if the grounding instructions are not completely understood or if in doubt as to whether the generator is properly grounded.

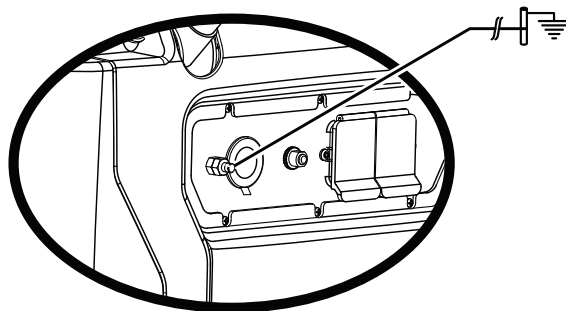

IMPORTANT SAFETY INSTRUCTIONS

DANGER:

Carbon Monoxide. Using a generator indoors CAN KILL YOU IN MINUTES.

Generator exhaust contains high levels of carbon monoxide (CO), a poisonous gas you cannot see or smell. If you can smell the generator exhaust, you are breathing CO. But even if you cannot smell the exhaust, you could be breathing CO.

- Never use a generator inside homes, garages, crawl spaces, or other partly enclosed areas. Deadly levels of carbon monoxide can build up in these areas. Using a fan or opening windows and doors does NOT supply enough fresh air.
- ONLY use a generator outdoors and far away from open windows, doors, and vents. These openings can pull in generator exhaust.

Even when you use a generator correctly, CO may leak into the home. ALWAYS use a battery-powered or battery-backup CO alarm in the home.

If you start to feel sick, dizzy, or weak after the generator has been running, move to fresh air RIGHT AWAY. See a doctor. You could have carbon monoxide poisoning.

WARNING:

Read and understand all instructions. Failure to follow all instructions listed below may result in electrocution, fire, and/or carbon monoxide poisoning, which will cause death or serious injury.

WARNING:

National Electric Code requires generator to be grounded to an approved earth ground. Before using the ground terminal, consult a qualified electrician, electrical inspector, or local agency having jurisdiction for local codes or ordinances that apply to the intended use of the generator.

SAVE THESE INSTRUCTIONS

This manual contains important instructions that should be followed during installation and maintenance of the generator and batteries.

- Do not connect to a building's electrical system unless the generator and transfer switch have been properly installed and the electrical output has been verified by a qualified electrician.
- Do not allow children or untrained individuals to use this unit.
- Never start or run the engine inside a closed or partially enclosed area. Breathing exhaust fumes will kill you.
- Wear eye protection which is marked to comply with ANSI Z87.1 as well as hearing protection when operating this equipment.
- Keep all bystanders, children, and pets at least 10 feet away.
- Wear sturdy and dry shoes or boots. Do not operate while barefoot.
- Do not operate generator when you are tired or under the influence of drugs, alcohol, or medication.
- Keep all parts of your body away from any moving parts and all hot surfaces of the unit.
- Do not touch bare wire or receptacles.
- Do not use generator with electrical cords which are worn, frayed, bare, or otherwise damaged.
- Before storing, allow the engine to cool and drain fuel from the unit.
- Do not operate or store the generator in rain, snow, or wet weather.
- Store the generator in a well-ventilated area with the fuel tank empty. Fuel should not be stored near the generator.
- Empty fuel tank, close fuel valve, and restrain the unit from moving before transporting in a vehicle.
- Allow engine to cool for five minutes before refueling.
- To reduce the risk of fire and burn injury, handle fuel with care. It is highly flammable.
- Do not smoke while handling fuel.
- Store fuel in a container approved for gasoline.
- Position the unit on level ground, stop engine, and allow to cool before refueling.
- Loosen fuel cap slowly to release pressure and to keep fuel from escaping around the cap.
- Tighten the fuel cap securely after refueling.
- Wipe spilled fuel from the unit.
- Never attempt to burn off spilled fuel under any circumstances.
- Generators vibrate in normal use. During and after the use of the generator, inspect the generator as well as extension cords and power supply cords connected to it for damage resulting from vibration. Have damaged items repaired or replaced as necessary. Do not use plugs or cords that show signs of damage such as broken or cracked insulation or damaged blades.
- For power outages, permanently installed stationary generators are better suited for providing back-up power to the home. Even a properly connected portable generator can become overloaded. This may result in overheating or stressing the generator components, possibly leading to generator failure.
- Use only authorized replacement parts and accessories and follow instructions in the section of this manual. Use

IMPORTANT SAFETY INSTRUCTIONS

of unauthorized parts or failure to follow maintenance instructions may create a risk of shock or injury.

- Maintain the unit per maintenance instructions in this Operator's Manual.

- Inspect the unit before each use for loose fasteners, fuel leaks, etc. Replace damaged parts.

SPECIFIC SAFETY RULES



WARNING:

When this generator is used to supply a building wiring system: generator must be installed by a qualified electrician and connected to a transfer switch as a separately derived system in accordance with NFPA 70, National Electrical Code. The generator shall be connected through a transfer switch that switches all conductors other than the equipment grounding conductor. The frame of the generator shall be connected to an approved grounding electrode. Failure to isolate the generator from power utility can result in death or injury to electric utility workers.











- Exhaust contains poisonous carbon monoxide, a colorless, odorless gas. Breathing exhaust can cause loss of consciousness and can lead to death. If running in a confined or partially-enclosed area, the air may contain a dangerous amount of carbon monoxide. To keep exhaust fumes from building up, always provide adequate ventilation.
- Always use a battery-powered carbon monoxide detector when running the generator. If you begin to feel sick, dizzy, or weak while using the generator, shut it off and get to fresh air immediately. See a doctor. You may have carbon monoxide poisoning.
- Place the generator on a flat, stable surface with a slope of no more than 4°.
- Operate in a well-ventilated, well-lit area isolated from working areas to avoid noise interference.
- Operating the generator in wet conditions could result in electrocution. Keep the unit dry.
- Keep the generator a minimum of 3 feet away from all types of combustible material.
- Do not operate generator near hazardous material.
- Do not operate generator at a gas or natural gas filling station.
- Do not touch the muffler or cylinder during or immediately after use; they are HOT and will cause burn injury.
- This generator has a neutral bonded condition. This means the neutral conductor is electrically connected to the frame of the machine.
- Do not allow the generator's gas tank to overflow when filling. Fill to 1 in. below the top neck of the gasoline tank to allow for fuel expansion. Do not cover the fuel tank cap when the engine is running. Covering the fuel tank cap during use may cause engine failure and/or damage to the tool.
- Do not smoke when filling the generator with gasoline.
- Shut down the engine and allow to cool completely before adding gasoline or lubricant to the generator.
- Do not remove the oil dipstick or the fuel tank cap when the engine is running.
- Pay close attention to all safety labels located on the generator.
- Keep children a minimum of 10 feet away from the generator at all times.
- The unit operates best in temperatures between 23°F and 104°F with a relative humidity of 90% or less.
- Specific modifications for high-altitude performance are needed if the generator will **always** be operated at altitudes above 5,000 feet. Contact your nearest authorized service center for more information and to have these modifications performed.
- Operating voltage and frequency requirement of all electronic equipment should be checked prior to plugging them into this generator. Damage may result if the equipment is not designed to operate within a +/- 10% voltage variation, and +/- 3 Hz frequency variation from the generator name plate ratings. To avoid damage, always have an additional load plugged into the generator if solid state equipment (such as a television set) is used. A power line conditioner is recommended for some solid state applications.
- Save these instructions. Refer to them frequently and use them to instruct others who may use this product. If you loan someone this product, loan them these instructions also.

SYMBOLS

The following signal words and meanings are intended to explain the levels of risk associated with this product.

SYMBOL	SIGNAL	MEANING
	DANGER:	Indicates an imminently hazardous situation, which, if not avoided, will result in death or serious injury.
	WARNING:	Indicates a potentially hazardous situation, which, if not avoided, could result in death or serious injury.
	CAUTION:	Indicates a potentially hazardous situation, which, if not avoided, may result in minor or moderate injury.
	CAUTION:	(Without Safety Alert Symbol) Indicates a situation that may result in property damage.

Some of the following symbols may be used on this product. Please study them and learn their meaning. Proper interpretation of these symbols will allow you to operate the product better and safer.

SYMBOL	NAME	DESIGNATION/EXPLANATION
	Safety Alert	Indicates a potential personal injury hazard.
	Wet Conditions Alert	Do not expose to rain or use in damp locations.
	Read The Operator's Manual	To reduce the risk of injury, user must read and understand operator's manual before using this product.
	Eye Protection	Always wear eye protection marked to comply with ANSI Z87.1.
	Electric Shock	Failure to use in dry conditions and to observe safe practices can result in electric shock.
	Toxic Fumes	Running generator gives off carbon monoxide, an odorless, colorless, poison gas. Breathing carbon monoxide can cause nausea, fainting, or death.
	Fire/Explosion	Fuel and its vapors are extremely flammable and explosive. Fire or explosion can cause severe burns or death.
	Hot Surface	To reduce the risk of injury or damage, avoid contact with any hot surface.
	Lifting Hazard	To reduce the risk of serious injury, avoid attempting to lift the generator alone.
	Ground	Consult with local electrician to determine grounding requirements before operation.

SYMBOLS

Some of the following symbols may be used on this product. Please study them and learn their meaning. Proper interpretation of these symbols will allow you to operate the product better and safer.

SYMBOL	NAME	DESIGNATION/EXPLANATION
	Electrocution	Failure to properly ground generator can result in electrocution, especially if the generator is equipped with a wheel kit.
V	Volts	Voltage
A	Amperes	Current
Hz	Hertz	Frequency (cycles per second)
W	Watt	Power
hrs	Hours	Time
gal	Gallon	Volume
qt	Quart	Volume

SAFETY LABELS

The information below can be found on the generator. For your safety, please study and understand all of the labels before starting the generator.

If any of the labels come off the unit or become hard to read, contact an authorized service center for replacement.

- You WILL be KILLED or SERIOUSLY HURT if you do not follow the Operator's Manual instructions.
- Risk of Fire. Do not add fuel while the product is operating.
- Generator is a potential source of electric shock. Do not expose to moisture, rain, or snow. Do not operate with wet hands or feet.
- Exhaust contains poisonous carbon monoxide gas that can cause unconsciousness or DEATH. Operate in well-ventilated, outdoor areas away from open windows or doors.
- Failure to properly ground generator can result in electrocution, especially if the generator is equipped with a wheel kit.
- Do not expose to rain or use in damp locations.
- Using a generator indoors CAN KILL YOU IN MINUTES. Generator exhaust contains carbon monoxide. This is a poison you cannot see or smell.
- NEVER use inside a home or garage, EVEN IF doors and windows are open.
- Only use OUTSIDE and far away from windows, doors, and vents.

⚠ DANGER

Using a generator indoors CAN KILL YOU IN MINUTES. Generator exhaust contains carbon monoxide. This is a poison you cannot see or smell.



NEVER use inside a home or garage, EVEN IF doors and windows are open.



Only use OUTSIDE and far away from windows, doors, and vents.

⚠ DANGER

L'utilisation d'une génératrice à l'intérieur PEUT VOUS TUER EN QUELQUES MINUTES.

Les génératrices produisent du monoxyde de carbone, un gaz mortel incolore et inodore.

NE JAMAIS utiliser à l'intérieur d'une maison ou d'un garage, MÊME SI les portes et les fenêtres sont ouvertes. Utiliser uniquement À L'EXTÉRIEUR et loin des fenêtres, des portes et des événements.

⚠ PELIGRO

Usar un generador en el interior PUEDE MATARLO EN POCOS MINUTOS.

Los gases de escape del generador contienen monóxido de carbono. Es un veneno que no puede verse ni olerse. NUNCA lo use dentro de su hogar o del garaje, INCLUSO con las puertas y las ventanas abiertas. Sólo utilícelo AL AIRE LIBRE y lejos de ventanas, puertas y respiraderos.

SYMBOLS

FUEL WARNING

No smoking when filling with gasoline. Do not overfill. Full level is 1 in. below the top of the fuel neck. Stop the engine for five minutes before refueling to avoid the heat from the muffler igniting fuel vapors.







ENGINE LUBRICANT WARNING

You must add lubricant before first operating the generator. The oil reservoir capacity is 20 oz. Always check the lubricant level before each operation. The lubricant level should always register between the hatched areas on the dipstick.

GROUNDING WARNING

National Electric Code requires generator to be grounded to an approved earth ground.

⚠ DANGER

 <p>You WILL be KILLED or SERIOUSLY HURT if you do not follow the operator's manual instructions.</p>	 <p>Generator is a potential source of electric shock. Do not expose to moisture, rain, or snow. Do not operate with wet hands or feet.</p>	 <p>Failure to properly ground generator can result in electrocution, especially if the generator is equipped with a wheel kit.</p>
 <p>Risk of fire. Do not add fuel while the product is operating.</p>	 <p>Exhaust contains poisonous carbon monoxide gas that can cause unconsciousness or DEATH. Operate in well ventilated, outdoor areas away from open windows or doors.</p>	 <p>Do not expose to rain or use in damp locations.</p>

940708012-01

⚠ DANGER ⚠ PELIGRO

	<p>Risk of Fire. Check for any fuel overflow or leaking. Stop the engine before refueling.</p> <p>Riesgo de incendio. Revise si hay algún derrame o fuga de combustible. Apague el motor antes de poner combustible.</p>
---	--

940974004-01

	<p>Add lubricant to full mark to start.</p> <p>Añada lubricante hasta la marca de lleno para arrancar.</p>
--	--

940708012-01

⚠ WARNING ⚠ ADVERTENCIA

Product does not include ground rod or copper wire. National Electric Code requires generator to be properly grounded to an approved earth ground. Call an electrician for local grounding requirements.

El producto no incluye el alambre de cobre ni la barra de conexión a tierra. Los Reglamentos Nacionales de Electricidad exigen que el generador esté debidamente conectado a una tierra aprobada. Comuníquese con un electricista para todo lo relacionado con los requisitos de conexión a tierra.

940513013-00

HOT SURFACE WARNING

Do not touch the muffler or aluminum cylinder of the engine. They are very HOT and will cause severe burns. Don't put any flammable or combustible materials in the direct path of the exhaust.

	<p>⚠ WARNING</p> <p>HOT SURFACE</p> <p>⚠ ADVERTENCIA</p> <p>SUPERFICIE CALIENTE</p>
--	---

940680036-00

ELECTRICAL

EXTENSION CORD CABLE SIZE

Refer to the table below to ensure the cable size of the extension cords you use are capable of carrying the required load. Inadequate size cables can cause a voltage drop, which can damage the appliance and overheat the cord.

Current in Amperes	Load in Watts		Maximum Allowable Cord Length				
	At 120V	At 240V	#8 Wire	#10 Wire	#12 Wire	#14 Wire	#16 Wire
2.5	300	600		1000 ft.	600 ft.	375 ft.	250 ft.
5	600	1200		500 ft.	300 ft.	200 ft.	125 ft.
7.5	900	1800		350 ft.	200 ft.	125 ft.	100 ft.
10	1200	2400		250 ft.	150 ft.	100 ft.	50 ft.
15	1800	3600		150 ft.	100 ft.	65 ft.	
20	2400	4800	175 ft.	125 ft.	75 ft.		
25	3000	6000	150 ft.	100 ft.			
30	3600	7200	125 ft.	65 ft.			
40	4800	9600	90 ft.				

ELECTRIC MOTOR LOADS

It is characteristic of common electric motors in normal operation to draw up to six times their running current while starting. This table may be used to estimate the watts required to start "Code G" electric motors; however, if an electric motor fails to start or reach running speed, turn off the appliance or tool immediately to avoid equipment damage. Always check the requirements of the tool or appliance being used compared to the rated output of the generator.

Motor Size (H.P.)	Running Watts	Watts Required to Start Motor		
		Repulsion Induction	Capacitor	Split Phase
1/8	275	600	850	1200
1/6	275	600	850	2050
1/4	400	850	1050	2400
1/3	450	975	1350	2700
1/2	600	1300	1800	3600
3/4	850	1900	2600	—
1	1100	2500	3300	—

CAUTION:

Operating voltage and frequency requirement of all electronic equipment should be checked prior to plugging them into this generator. Damage may result if the equipment is not designed to operate within a +/- 10% voltage variation, and +/- 3 hz frequency variation from the generator name plate ratings. To avoid damage, always have an additional load plugged into the generator if solid state equipment (such as a television set) is used. A power line conditioner is recommended for some solid state applications.

GROUND FAULT CIRCUIT INTERRUPTER

See Figure 1.

The 20 amp, 120 volt receptacles on the generator are protected by a Ground Fault Circuit Interrupter (GFCI), which guards against the hazards of ground fault currents. An example of

ground fault current is the current that would flow through a person who is using an appliance with faulty insulation and, at the same time, is in contact with an electrical ground such as a plumbing fixture, wet floor, or earth.

GFCI receptacles do not protect against short circuits, overloads, or shocks.

The GFCI receptacles can be tested with the TEST and RESET buttons.

To test:

- Depress the TEST button. This should cause the Reset button to pop out.
- To restore power, depress the RESET button.

Perform this test monthly to ensure proper operation of the GFCI. If the generator is stored outdoors, unprotected from the weather, test the GFCI receptacle before each use.

ELECTRICAL

GENERATOR CAPACITY

Make sure the generator can supply enough continuous (running) and surge (starting) watts for the items you will power at the same time. Follow these simple steps.

1. Select the items you will power at the same time.
2. Total the continuous (running) watts of these items. This is the amount of power the generator must produce to keep the items running. See the wattage reference chart at right.
3. Estimate how many surge (starting) watts you will need. Surge wattage is the short burst of power needed to start electric motor-driven tools or appliances such as a circular saw or refrigerator. Because not all motors start at the same time, total surge watts can be estimated by adding only the item(s) with the highest additional surge watts to the total rated watts from step 2.

Example:

Tool or Appliance	Continuous Running) Watts	Surge (Starting) Watts
Furnace Fan	800	2350
Refrigerator	700	2200
Well Pump	1000	1500
Light (75 Watts) x 4	300	300
	2800 Total Running Watts	2350 Highest Surge Watts

Total Continuous (Running) Watts 2800
 Plus Highest Additional Surge Watts + 2350
 Equals Total Generator Output Required 5150

POWER MANAGEMENT

To prolong the life of the generator and attached devices, it is important to take care when adding electrical loads to the generator. There should be nothing connected to the generator outlets before starting its engine. The correct and safe way to manage generator power is to sequentially add loads as follows:

1. With nothing connected to the generator, start the engine as described later in this manual.
2. Plug in and turn on the first load, preferably the largest load you have.
3. Permit the generator output to stabilize (engine runs smoothly and attached device operates properly).
4. Plug in and turn on the next load.
5. Again, permit the generator to stabilize.
6. Repeat steps 4 and 5 for each additional load.

Never add more loads than the generator capacity. Take special care to consider surge loads in generator capacity as previously described.

CAUTION:

Do not overload the generator's capacity. Exceeding the generator's wattage/ampere capacity can damage the generator and/or electrical devices connected to it.

Application/Equipment	Estimated Run Watts	Estimated Starting Watts
Emergency / Home Standby		
Clock Radio	50	50
Lights (qty. 4 x 75 W)	300	300
Refrigerator	700	2200
Furnace Fan	800	2350
Water Well Pump	1000	1500
Microwave	1000	1000
Sump Pump	1050	2200
Electric Range (per element)	2100	2100
Job Site		
Electric Drill – 1/2 HP	600	900
Airless Sprayer – 1/3 HP	600	1200
Quartz Halogen Work Light	1000	1000
Reciprocating Saw	960	1920
Air Compressor – 1 HP	1600	4500
Circular Saw – 7-1/4 in.	1400	2300
Planer/Joiner – 6 in	1800	1800
Miter Saw – 10 in.	1800	1800
Table Saw/Radial Arm Saw – 10 in.	2000	2000

*Wattages listed are approximate. Check tool or appliance for actual wattage.

FEATURES

PRODUCT SPECIFICATIONS

ENGINE

Engine Type	169cc Subaru
Cooling System	Forced Air
Starting System	Recoil
Ignition System	T.C.I.
Spark Plug	Champion RL86C
Engine Lubricant Volume.....	20 oz.
Fuel Volume	2 gal.

GENERATOR

Rated Voltage	120V AC / 12V DC
Rated Amps.....	18.75 A / 15 A
Rated Output.....	2,250 W
Maximum Output.....	2,800 W
Rated Frequency	60 Hz

DIMENSIONS

Length	17-1/2 in.
Width	23-1/3 in.
Height	16-1/2 in.

KNOW YOUR GENERATOR

See Figure 2.

The safe use of this product requires an understanding of the information on the product and in this operator's manual as well as a knowledge of the project you are attempting. Before use of this product, familiarize yourself with all operating features and safety rules.

AC CIRCUIT BREAKER

The circuit breaker is provided to protect the generator against electrical overload.

AIR FILTER

The air filter helps to limit the amount of dirt and dust drawn into the unit during operation.

CHOKE LEVER

The choke lever is used when starting the engine.

FUEL TANK

The fuel tank has a capacity of 2 gallons.

GROUND TERMINAL

The ground terminal is used to assist in properly grounding the generator to help protect against electrical shock. Consult with a local electrician for grounding requirements in your area.

OIL CAP

Remove the oil fill cap to check and add lubricant to the generator when necessary.

OIL DRAINAGE BOLT

When changing the engine lubricant, the oil drainage bolt is loosened to allow old engine lubricant to be drained.

RECEPTACLES

Your generator has the following single phase, 60 Hz outlets: two 120 Volt AC, 20 Amp GFCI receptacles, and one 12 Volt DC outlet. These can be used for operating appropriate appliances, electrical lighting, tools, and motor loads.

RECOIL STARTER GRIP

The recoil starter grip is used (along with the engine switch) to start the generator's engine.

ASSEMBLY

WARNING:

Do not attempt to operate the generator until assembly is complete. Failure to comply could result in possible serious personal injury.

PACKING LIST

See Figure 3.

The following items are included with the generator:

Key

No.	Description	Qty.
1	Wheels.....	2
2	Axle.....	2
3	Washer.....	2
4	Lanyard and Handle Lock Pin	1
5	Bottle of Engine Lubricant.....	1
6	Handle	1
7	Bolts	2
8	Nuts	2
	Operator's Manual (not shown)	1

UNPACKING

This product requires assembly.

- Carefully cut the box down the sides then remove the machine and any accessories from the box. Make sure that all items listed in the packing list are included.

NOTE: This machine is heavy and requires a minimum of two people to lift. To avoid back injury, lift with your legs and not your back.

WARNING:

Do not use this product if any parts on the Packing List are already assembled to your product when you unpack it. Parts on this list are not assembled to the product by the manufacturer and require customer installation. Use of a product that may have been improperly assembled could result in serious personal injury.

- Inspect the unit carefully to make sure no damage occurred during shipping.
- Do not discard the packing material until you have carefully inspected and satisfactorily operated the product.
- If any parts are damaged or missing, please call 1-800-242-4672 for assistance.

WARNING:

If any parts are damaged or missing do not operate this product until the parts are replaced. Failure to heed this warning could result in serious personal injury.

WARNING:

Do not attempt to modify this product or create accessories not recommended for use with this product. Any such alteration or modification is misuse and could result in a hazardous condition leading to possible serious personal injury.

WARNING:

Do not attempt to operate the generator until assembly is complete. Failure to comply could result in possible serious personal injury.

INSTALLING THE WHEELS

See Figure 4.

Wheels are provided to assist in moving the generator to the desired location.

- Locate the axle, washer, and wheels.
- Slide the axle through the hole in the center of the wheel then slide the washer onto the axle.
- Lift the machine and slide the axle into the wheel mounting hole in the machine base as shown.
- Push the wheel into the hole until it clicks in place and is secured properly.
- Repeat the process on the other side to install second wheel.

INSTALLING THE HANDLE

See Figures 5 - 6.

- Slide the handle into bracket and secure in place using bolts and nuts.
- Attach the lanyard to the handle lock pin and the handle as shown.
- Insert the pin through the hole in the handle and the generator frame to secure handle in place.

WARNING:

Do not attempt to lift the unit by the handle assembly. If it is necessary to lift the generator, always grasp by the frame. Use proper lifting techniques to avoid back injury.

OPERATION

DANGER:

Carbon Monoxide. Using a generator indoors CAN KILL YOU IN MINUTES.

Generator exhaust contains high levels of carbon monoxide (CO), a poisonous gas you cannot see or smell. If you can smell the generator exhaust, you are breathing CO. But even if you cannot smell the exhaust, you could be breathing CO.

- Never use a generator inside homes, garages, crawl-spaces, or other partly enclosed areas. Deadly levels of carbon monoxide can build up in these areas. Using a fan or opening windows and doors does NOT supply enough fresh air.
- ONLY use a generator outdoors and far away from open windows, doors, and vents. These openings can pull in generator exhaust.

Even when you use a generator correctly, CO may leak into the home. ALWAYS use a battery-powered or battery-backup CO alarm in the home.

If you start to feel sick, dizzy, or weak after the generator has been running, move to fresh air RIGHT AWAY. See a doctor. You could have carbon monoxide poisoning.

DANGER:

Failure to properly ground generator can result in electrocution, especially if the generator is equipped with a wheel kit. National Electric Code requires generator to be properly grounded to an approved earth ground. Call an electrician for local grounding requirements.

WARNING:

Do not allow familiarity with this product to make you careless. Remember that a careless fraction of a second is sufficient to inflict serious injury.

WARNING:

Do not use any attachments or accessories not recommended by the manufacturer of this product. The use of attachments or accessories not recommended can result in serious personal injury.

APPLICATIONS

This generator is designed to supply electrical power for operating compatible electrical lighting, appliances, tools, and motor loads.

BEFORE OPERATING THE UNIT

- Only use OUTSIDE and far away from windows, doors, and vents.
- NEVER use inside a home or garage, EVEN IF doors and windows are open.
- Always position the generator on a flat firm surface.

CAUTION:

Attempting to start the engine before it has been properly filled with lubricant will result in equipment failure.

CHECKING/ADDING LUBRICANT

See Figure 7.

Engine lubricant has a major influence on engine performance and service life. For general, all-temperature use, SAE 10W-30 is recommended. Always use a 4-stroke motor lubricant that meets or exceeds the requirements for API service classification SJ.

NOTE: Non-detergent or 2-stroke engine lubricants will damage the engine and should not be used.

- Unscrew the oil cap/dipstick and remove.
- Wipe dipstick clean and re-seat in hole; do not re-thread.
- Remove dipstick again and check lubricant level. Lubricant level should fall between the hatched areas on the dipstick.
- If level is low, add engine lubricant until the fluid level rises to the upper portion of the dipstick.
- Replace and secure the oil cap/dipstick.

CHECKING/ADDING FUEL

See Figure 8.

- Remove the fuel cap.
- Fill the fuel tank to 1 in. below the top of the fuel neck.
- Replace and secure the fuel cap.

NOTE: Always use unleaded gasoline with a pump octane rating of 86 or higher. Never use old, stale, or contaminated gasoline, and do not use an oil/gas mixture. Do not allow dirt or water into the fuel tank.

OPERATION

USING FUEL STABILIZER

Fuel gets old, oxidizes, and breaks down over time. Adding a fuel stabilizer (not included) extends the usable life of fuel and helps prevent deposits from forming that can clog the fuel system. Follow fuel stabilizer manufacturer's directions for correct ratio of stabilizer to fuel.

- Add stabilizer to fuel tank, then fill with gasoline following previous instructions.

NOTE: Fuel stabilizer and gasoline can be mixed prior to filling the tank by using a gas can or other approved fuel container and shaking gently to combine.

- Replace and secure the fuel tank cap.
- Start and run the engine for at least 5 minutes to allow stabilizer to treat the entire fuel system.

OXYGENATED FUELS

DO NOT USE E85 FUEL. IT WILL VOID YOUR WARRANTY.

NOTE: Fuel system damage or performance problems resulting from the use of an oxygenated fuel containing more than the percentages of oxygenates stated below are not covered under warranty.

Ethanol. Gasoline containing up to 10% ethanol by volume (commonly referred to as E10) or 15% ethanol by volume (commonly referred to as E15) are acceptable. E85 is not.

CAUTION:

On a level surface with the engine off, check the lubricant level before each use of the generator.

STARTING THE ENGINE

See Figures 9 - 11.

NOTE: If location of generator is not level, the unit may not start or may shut down during operation.

- Unplug all loads from the generator.
- Turn the fuel valve to the ON position.
- Move the choke lever right to the START position.
NOTE: If engine is warm or the temperature is above 50°F, move the choke lever left to the RUN position.
- Put the engine switch in the ON (I) position.
- Pull the recoil starting grip until the engine runs (a maximum of 6 times).
NOTE: Do not allow the grip to snap back after starting; return it gently to its original place.
- Allow the engine to run for 30 seconds, then move the choke lever left to the RUN position.

STOPPING THE ENGINE

See Figures 9 - 11.

To stop the engine under normal operating conditions:

- Remove any load from the generator.
- Turn the fuel valve to the OFF position.
- Put the engine switch in the OFF (O) position.

To stop the engine in an emergency situation:

- Put the engine switch in the OFF (O) position.

MAINTENANCE

WARNING:

When servicing, use only identical Husky replacement parts. Use of any other parts may create a hazard or cause product damage.

Only the parts shown on the parts list are intended to be repaired or replaced by the customer. All other parts should be replaced at an authorized service center.

GENERAL MAINTENANCE

Keep the generator in a clean and dry environment where it is not exposed to dust, dirt, moisture, or corrosive vapors. Do not allow the cooling air slots in the generator to become clogged with foreign material such as leaves, etc.

Do not use a garden hose to clean the generator. Water entering the fuel system or other internal parts of the unit can cause problems that will decrease the life of the generator.

To clean the unit:

- Use a soft bristle brush and/or vacuum cleaner to loosen and remove dirt and debris.
- Clean air vents with low pressure air that does not exceed 25 psi.
- Wipe the exterior surfaces of the generator with a damp cloth.

CHECKING/CLEANING AIR FILTER

See Figure 12.

For proper performance and long life, keep air filter clean.

- Locate the latch under the air filter and pull to release.
- Remove the air filter cover.
- Remove the filter element.
- If the filter element is dirty, clean with warm, soapy water. Rinse and let dry.
- Apply a light coat of engine lubricant to the element, then squeeze it out.
- Replace the element in the air filter unit.
- Replace the air filter cover and lock the latch.

NOTE: Do not run the generator without the air filter or gasket. Rapid engine wear will result.

CHANGING ENGINE LUBRICANT

See Figure 13.

- Remove the oil cap/dipstick.
- Place a container underneath the oil drainage bolt to collect used lubricant as it drains.
- Unscrew the oil drainage bolt and remove.
- Allow lubricant to drain completely.
- Reinstall the oil drainage bolt and tighten securely.
- Refill with lubricant following the instructions in the **Checking/Adding Lubricant** section.
- Reinstall the oil cap/dipstick.

NOTE: Used lubricant should be disposed of at an approved disposal site. See your local oil retailer for more information.

SPARK PLUG MAINTENANCE

See Figure 14.

The spark plug must be properly gapped and free of deposits in order to ensure proper engine operation. To check:

- Remove the spark plug cap.
- Clean any dirt from around base of spark plug.
- Remove spark plug using wrench (not included).
- Inspect spark plug for damage, and clean with a wire brush before reinstalling. If insulator is cracked or chipped, spark plug should be replaced.

NOTE: If replacing, use the following recommended spark plug or equivalent: Champion RL86C.

- Measure plug gap. The correct gap is 0.02–0.03 in. (0.6–0.7 mm). To widen gap, if necessary, carefully bend the ground (top) electrode. To lessen gap, gently tap ground electrode on a hard surface.
- Seat spark plug in position; thread in by hand to prevent cross-threading.
- Tighten with wrench to compress washer. If spark plug is new, use 1/2 turn to compress washer appropriate amount. If reusing old spark plug, use 1/8 to 1/4 turn for proper washer compression.

NOTE: An improperly tightened spark plug will become very hot and could damage the engine.

MAINTENANCE

CLEANING THE EXHAUST PORT AND MUFFLER

Depending on the type of fuel used, the type and amount of lubricant used, and/or your operating conditions, the exhaust port and muffler may become blocked with carbon deposits. If you notice a power loss with your gas-powered products, you may need to remove these deposits to restore performance. We highly recommend that only qualified service technicians perform this service.

SPARK ARRESTOR

See Figure 15.

The spark arrestor must be cleaned or replaced every 50 hours or yearly to ensure proper performance of your product. Spark arrestors may be in different locations depending on the model purchased. Please contact your nearest service dealer for the location of the spark arrestor for your model.

EMPTYING FUEL TANK/CARBURETOR

To help prevent gum deposits in the fuel system, drain the fuel from the tank and carburetor before storing.

- Run the generator until the fuel tank is empty.
- When the fuel has gone from the tank, close the fuel valve.

NOTE: Consult hazardous waste management guidelines in your area for the proper way to dispose of used fuel.

TRANSPORTING

- Turn engine switch OFF (O).
- Turn the fuel valve to the OFF position.
- Make sure engine and exhaust of unit is cool.
- Empty the fuel tank.
- Do not drop or strike unit or place under heavy objects.

MAINTENANCE

STORAGE

When preparing the generator for storage, allow the unit to cool completely then follow the guidelines below.

STORAGE TIME	PRIOR TO STORING
Less than 2 months	<ul style="list-style-type: none"> ■ Run the generator until the fuel tank is empty.
2 months to 1 year	<ul style="list-style-type: none"> ■ Start and run the engine for at least 5 minutes to allow stabilizer to treat the entire fuel system. ■ Run the generator until the fuel tank is empty.
1 year or more	<ul style="list-style-type: none"> ■ Start and run the engine for at least 5 minutes to allow stabilizer to treat the entire fuel system. ■ Remove spark plug. ■ Run the generator until the fuel tank is empty. ■ Put a tablespoon of engine oil into the spark plug cylinder. Turn the engine slowly with the pull rope to distribute the oil. ■ Reinstall spark plug. ■ Change engine lubricant. <p>After removal from storage:</p> <ul style="list-style-type: none"> ■ Fill with fresh gasoline.

MAINTENANCE SCHEDULE

	Before each use	After 1st month or 20 hours of operation	Every 3 months or 50 hours of operation	Every 6 months or 100 hours of operation	Every year or after 300 hours of operation
Check Engine Lubricant	■				
Change Engine Lubricant		■		■	
Check Air Filter	■				
Clean Air Filter			■		
Change Air Filter					■
Check/Adjust Spark Plug				■	
Replace Spark Plug					■
Check/Adjust Idle Speed					■
Check/Adjust Valve Clearance*					■
Clean Fuel Tank and Filter*				■	
Check Fuel Tube					■

* These items should only be carried out by an authorized service center.

NOTE: Maintenance should be performed more frequently when generator is used in dusty areas.

When generator has exceeded the maximum figures specified in the table, maintenance should still be cycled according to the intervals of time or hours stated herein.

TROUBLESHOOTING

PROBLEM	POSSIBLE CAUSE	SOLUTION
Engine will not start.	Engine switch is OFF. No fuel. Lubricant level is low. Fuel valve is OFF. Spark plug faulty, fouled, or improperly gapped. Choke lever is in RUN position. Engine stored without treating or draining gasoline, or refueled with bad gasoline.	Turn engine switch to ON. Fill fuel tank. Check engine lubricant level and fill, if necessary. Turn fuel valve ON. Replace spark plug. Move choke lever to START position. Drain fuel and carburetor. Refuel with fresh gasoline.
Engine lacks power.	Fuel element clogged. Engine stored without treating or draining gasoline, or refueled with bad gasoline.	Check air filter element. Clean or replace as needed. Drain fuel and carburetor. Refuel with fresh gasoline. If problem continues, contact your nearest authorized service center.
AC receptacle does not work.	Circuit breaker is OFF. Item plugged in is defective.	Turn ON the AC circuit breaker. Try a different item.
Generator makes a “spark knock” or “pinging” noise.	An occasional light “knocking” or “pinging” under heavy load is not a cause for concern. However, if the knocking or pinging occurs under normal load at a steady engine speed, the problem may be with the brand of gasoline being used.	Switch to a different brand of gasoline, making sure that the octane rating is 86 or higher. If problem continues, contact your nearest authorized service center.
If problem persists after trying the above solutions, contact your nearest authorized service center for assistance.		
The following symptoms may indicate problems that will affect the emissions level of the unit: <ul style="list-style-type: none"> ■ Hard starting or stalling after starting ■ Rough idle ■ Misfiring or backfiring under load ■ Afterburning (backfiring) ■ Black exhaust smoke or high fuel consumption If you encounter any of these symptoms, have the unit inspected and repaired by the nearest authorized service center.		

WARRANTY

LIMITED WARRANTY

WARRANTY COVERAGE

Techtronic Industries North America, Inc., (the Company) warrants to the original retail purchaser that this Husky Product is free from defects in material and workmanship and agrees to repair or replace, at the Company's sole discretion, any defective Product free of charge within these time periods from the date of purchase:

- Three years, if the Product is used solely for personal, family, or household use;
- One year, if the Product is used for business or commercial use.

This warranty applies only to Products sold within the United States of America, the District of Columbia, Canada, Mexico, the Commonwealth of Puerto Rico, the Virgin Islands, Guam, the Canal Zone, or American Samoa.

This warranty is not transferable and does not cover damage resulting from defects other than in material or workmanship, or damage caused by unreasonable use, including the failure to provide reasonable and necessary maintenance. Other items not covered under this warranty include:

- Transportation charges for sending the product to the Company or its authorized service representative for warranty service, or for shipping repaired or replacement products back to the customer; these charges must be borne by the original retail purchaser.
- Engine. Your Product is equipped with an engine that is covered exclusively by a separate warranty from the engine manufacturer. Please refer to the engine manual included with the Product for warranty information related to the engine.
- Damages caused by abuse, accident, misuse, neglect, alteration, modification, the effects of corrosion, erosion, normal wear and tear or repairs by other than the Company or its authorized service representative.

Warranty is voided if the customer fails to install, maintain and operate the product in accordance with the instructions and recommendations of the Company as set forth in the Product's operator's manual or if the Product is used as rental equipment.

The Company will not pay for repairs or adjustments to the Product, or for any costs or labor, performed without the Company's prior authorization.

SAVE YOUR SALES SLIP

Proof of purchase in the form of your dated sales receipt, cash register slip, etc. showing the serial number and the model of your Product will be required before the Company and/or its authorized service representatives can perform warranty service on the Product.

EXCLUSIONS AND LIMITATIONS

THIS LIMITED WARRANTY IS IN LIEU OF ALL OTHER EXPRESS WARRANTIES. ANY IMPLIED WARRANTY OF MERCHANTABILITY, FITNESS FOR A PARTICULAR PURPOSE, OR OTHERWISE, APPLICABLE TO THIS PRODUCT, SHALL BE LIMITED IN DURATION TO THE DURATION OF THIS LIMITED WARRANTY. THE WARRANTY SERVICE DESCRIBED ABOVE IS THE EXCLUSIVE REMEDY UNDER THIS WARRANTY. THE COMPANY SHALL NOT BE LIABLE FOR ANY SPECIAL, INCIDENTAL OR CONSEQUENTIAL DAMAGES.

SOME STATES DO NOT ALLOW A LIMITATION ON THE DURATION OF IMPLIED WARRANTIES, OR THE EXCLUSION OR LIMITATION OF INCIDENTAL, OR CONSEQUENTIAL DAMAGES, SO THE ABOVE LIMITATION OR EXCLUSION MAY NOT APPLY TO YOU.

HOW TO OBTAIN WARRANTY SERVICE

For warranty service: Call toll free 1-866-340-3912, or write to Techtronic Industries North America, Inc., P.O. Box 35, Highway 8, Pickens, SC 29671.

For warranty service outside the USA, please contact your local Husky dealer.

WARRANTY

EVAPORATIVE EMISSION CONTROL WARRANTY

Your new HUSKY brand gasoline-powered product complies with all applicable U.S. EPA, Environment Canada, and State of California emissions regulations.

The evaporative emissions portion of this coverage, as described below, is provided by Techtronic Industries North America, Inc. Separate emissions warranty coverage for other emissions-related components is provided by the engine manufacturer, as stated in a separate "Emission Control System Warranty" included with this product. Of course, this product also includes a warranty that is not limited to emissions-related components, as described elsewhere in this operator's manual.

EVAPORATIVE EMISSION CONTROL WARRANTY STATEMENT

CALIFORNIA EVAPORATIVE EMISSION CONTROL WARRANTY STATEMENT

YOUR WARRANTY RIGHTS AND OBLIGATIONS

The California Air Resources Board and Techtronic Industries North America, Inc., are pleased to explain the evaporative emission control system's warranty on your 2010 model year generator. In California, new equipment that uses small off-engines must be designed, built, and equipped to meet the State's stringent anti-smog standards. Techtronic Industries North America, Inc., must warrant the evaporative emission control system on your generator for the period listed below, provided there has been no abuse, neglect or improper maintenance of your equipment.

Your evaporative emission control system may include parts such as: carburetors, fuel tanks, fuel lines, fuel caps, valves, canisters, filters, vapor hoses, clamps, connectors, and other associated components. For engines less than or equal to 80 cc, only the fuel tank is subject to the evaporative emission control warranty requirements of this section.

MANUFACTURER'S WARRANTY COVERAGE:

This evaporative emission control system is warranted for two years. If any evaporative emission-related part on your equipment is defective, the part will be repaired or replaced by Techtronic Industries North America, Inc.

OWNER'S WARRANTY RESPONSIBILITIES:

- As the generator owner, you are responsible for performance of the required maintenance listed in your operator's manual. Techtronic Industries North America, Inc., recommends that you retain all receipts covering maintenance on your generator, but Techtronic Industries North America, Inc., cannot deny warranty solely for the lack of receipts.
- As the generator owner, you should, however, be aware that Techtronic Industries North America, Inc., may deny you warranty coverage if your generator or a part has failed due to abuse, neglect, or improper maintenance or unapproved modifications.
- You are responsible for presenting your generator to a Techtronic Industries North America, Inc., distribution center or service center as soon as the problem exists. The warranty repairs should be completed in a reasonable amount of time, not to exceed 30 days.

If you have a question regarding your warranty coverage, you should contact Techtronic Industries North America, Inc., at 1-866-340-3912.

DEFECTS WARRANTY REQUIREMENTS:

- (a) The warranty period begins on the date the equipment is delivered to an ultimate purchaser.
- (b) General Evaporative Emissions Warranty Coverage. The equipment must be warranted to the ultimate purchaser and any subsequent owner that the evaporative emission control system when installed was:
 - (1) Designed, built, and equipped so as to conform with all applicable regulations; and
 - (2) Free from defects in materials and workmanship that cause the failure of a warranted part for a period of two years.
- (c) The warranty on evaporative emissions-related parts will be interpreted as follows:

- (1) Any warranted part that is not scheduled for replacement as required maintenance in the written instructions must be warranted for the warranty period defined in subsection (b)(2). If any such part fails during the period of warranty coverage, it must be repaired or replaced by the manufacturer issuing the warranty. Any such part repaired or replaced under the warranty must be warranted for a time not less than the remaining warranty period.
- (2) Any warranted part that is scheduled only for regular inspection in the written instructions must be warranted for the warranty period defined in subsection (b)(2). A statement in such written instructions to the effect of "repair or replace as necessary" will not reduce the period of warranty coverage. Any such part repaired or replaced under warranty must be warranted for a time not less than the remaining warranty period.
- (3) Any warranted part that is scheduled for replacement as required maintenance in the written instructions must be warranted for the period of time prior to the first scheduled replacement point for that part. If the part fails prior to the first scheduled replacement, the part must be repaired or replaced by the manufacturer issuing the warranty. Any such part repaired or replaced under warranty must be warranted for a time not less than the remainder of the period prior to the first scheduled replacement point for the part.
- (4) Repair or replacement of any warranted part under the warranty provisions of this article must be performed at no charge to the owner at a warranty station.
- (5) Notwithstanding the provisions of subsection (4) above, warranty services or repairs must be provided at distribution centers that are franchised to service the subject equipment.
- (6) The owner must not be charged for diagnostic labor that leads to the determination that a warranted part is in fact defective, provided that such diagnostic work is performed at a warranty station.
- (7) Throughout the evaporative emission control system's warranty period set out in subsection (b)(2), the manufacturer issuing the warranty must maintain a supply of warranted parts sufficient to meet the expected demand for such parts.
- (8) Manufacturer approved replacement parts must be used in the performance of any warranty maintenance or repairs and must be provided without charge to the owner. Such use will not reduce the warranty obligations of the manufacturer issuing the warranty.
- (9) The use of any add-on or modified parts will be grounds for disallowing a warranty claim made in accordance with this article. The manufacturer issuing the warranty will not be liable under this Article to warrant failures of warranted parts caused by the use of an add-on or modified part.
- (10) The manufacturer issuing the warranty shall provide any documents that describe the warranty procedures or policies within five working days of request by the Air Resources Board.

EMISSION WARRANTY PARTS LIST:

- 1) Fuel Tank
- 2) Fuel Cap
- 3) Fuel Hoses
- 4) Carbon Canister
- 5) Vapor Hoses
- 6) Hose Clamps
- 7) Hose Connectors
- 8) Vapor/Fuel Check Valve

Written instructions for the maintenance and use of the evaporative emissions control system by the owner shall be furnished with each new generator.

