



GAS PRESSURE WASHER OWNER'S MANUAL 039-8595-6



Questions?

If you have a question or if there are missing parts,
please call:

1-866-4SIMONIZ

(1-866-474-6664)

Monday-Saturday 7:00 am-8:00 pm EST

Product#: 039-8595-6

Serial #: _____

Purchase Date: _____

! TO PREVENT DAMAGE AND BODILY HARM, ENSURE ENTIRE MANUAL HAS BEEN READ BEFORE OPERATING PRESSURE WASHER UNIT. ANY QUESTIONS OR CONCERNS REGARDING THIS MANUAL SHOULD BE DIRECTED TO THE SIMONIZ TOLL-FREE NUMBER.

TABLE OF CONTENTS

SPECIFICATIONS.....	2
SAFETY INSTRUCTIONS.....	3
PRESSURE WASHER FEATURES.....	8
ASSEMBLY AND PRE-START CHECK.....	9
START-UP PROCEDURES & OPERATIONS.....	12
TROUBLESHOOTING.....	16
MAINTENANCE.....	17
DIAGRAM & PARTS LIST.....	20
LIMITED WARRANTY.....	22

SPECIFICATIONS





Model	S3200
Product #	039-8595-6
Maximum/Rated Water Pressure	3200PSI/2500PSI
Maximum Water Volume	2.6 GPM
Maximum Inlet Pressure	90 PSI
Pump Type	Heavy-duty maintenance-free axial cam
Thermal Relief Valve	Yes
Detergent Tank (Volume)	X2 0.2 G Detergent Tanks
Maximum Temperature of Pumped Fluid	60°C
Engine Power (OHV)	6.5 HP
No Load Speed	3,600 RPM
High Pressure Hose Length	50 feet
Displacement	196 (cc)
Wheels	10" (25.4 cm) pneumatic
Net/Gross Weight	81.6 lbs
Oil Specification	SAE 10W-30
Oil Capacity (L)	0.6L
Fuel	Unleaded Gasoline
Fuel Tank (L)	4 L

SAFETY INSTRUCTIONS

⚠ WARNING

To reduce the risk of serious injury, read all instructions and precautions before operating this machine.

SYMBOL MEANINGS:

	TOXIC	This symbol warns you of possible toxic gases which can be harmful to your health or deadly if you are exposed to them.
	FLAMMABLE AND COMBUSTIBLE MATERIALS	This symbol warns of materials/gases which are present and extremely flammable. When you see this symbol, be very cautious not to ignite the material/gases.
	VERY POISONOUS	This symbol warns of materials, gases, etc. which are very poisonous and would cause serious bodily harm or death. When you see this symbol, please take proper precautions.
	HOT SURFACE	This symbol warns of a hot surface which could cause damage to material and/or damage to human skin if touched. Please take proper precautions when you see this symbol.
	GENERAL WARNING	This symbol indicates that serious bodily injury or death could occur if proper precautions are not taken. These are warning statements which do not fall into the above categories



EXHAUST FUMES ARE DANGEROUS

- Never operate unit in enclosed areas such as garages, basements, storage, sheds, or in any location occupied by humans or animals. Never operate the engine in a closed area or it may cause unconsciousness and death within a short time. Operate pressure washer in clean, dry, well ventilated area.
- ⚠ Keep children, pets and others away from area of operating unit. Breathing exhaust fumes will cause serious injury or death.
- ⚠ **WARNING** Gasoline engines produce toxic carbon monoxide exhaust fumes.



INADEQUATE VENTILATION

- Materials placed against or near the pressure washer or operating in areas where the temperature exceeds 40°C ambient (such as storage rooms or garages) can interfere with its proper ventilation features causing overheating and possible ignition of the materials or buildings.
- Operate pressure washer in a clean, dry, well-ventilated area a minimum of 4' (1.2 m) four feet from any building, object or wall. **DO NOT OPERATE UNIT INDOORS OR IN ANY CONFINED AREA.**



FUEL IS HIGHLY FLAMMABLE AND POISONOUS

- Always turn off the engine when refuelling.
- Never refuel while smoking or in the vicinity of an open flame.
- When operating or manoeuvring this pressure washer, be sure to keep it upright. If it tilts, fuel may leak from the carburetor or fuel tank.



DO NOT ATTEMPT TO FILL GASOLINE TANK WHILE ENGINE IS RUNNING.

- Gasoline and gasoline vapours can become ignited by coming into contact with hot components such as the muffler, engine exhaust gases, or from an electrical spark.
- Turn engine off and allow it to cool before adding fuel to the tank. Equip the area of operation with a fire extinguisher certified to handle gasoline or fuel fires.



SPARKS, FIRE, HOT OBJECTS

- Cigarettes, sparks, fires, or other hot objects can cause gasoline or gasoline vapours to ignite.



ENGINE AND MUFFLER MAY BE HOT

- Place the pressure washer in an appropriate location, away from children and pedestrians.
- Avoid placing any flammable materials near the exhaust outlet during operation or shortly thereafter.
- Keep a 4' (1.2 m) clearance from buildings or other equipment around the pressure washer to prevent overheating.

⚠ WARNING The engine muffler will be very hot during and after use, avoid touching the engine or muffler while they are still hot.



HOT MUFFLER & HIGH PRESSURE HOSE

- Muffler will become very hot during operation. **DO NOT TOUCH MUFFLER WHILE IN USE OR SHORTLY THEREAFTER.**
- Keep hose away from the hot muffler or it may damage the hose. Do not use a damaged high pressure hose. Do not kink the high pressure hose.

APPLICATION



STAIRS



LAWN EQUIPMENT



VEHICLE



FENCING



DECK OR PATIO



GARAGE FLOOR



DRIVEWAY



SECOND STORY



SIDING



PAINT PREP

- This equipment is designed for specific residential applications. Do not modify or use for any application other than which it is designed. This equipment is not designed for industrial use. Please refer to icons above for suggested uses. For questions regarding other uses, please refer to our website at www.simoniz.ca or call us at **1-866-4SIMONIZ (1-866-474-6664)**.

NEVER OPERATE UNDER THE FOLLOWING CONDITIONS

- When a noticeable change in engine speed occurs.
- Engine misfires.
- Loss of water pressure.
- Smoke or flames in the area.
- Excessive vibration.



WATER SPRAY

- Never direct the water spray towards ANY person, animal, electrical wiring or the pressure washer itself.
- **DO NOT** spray too close to the surface or damage could occur.
- The vendor is not responsible for damage caused by improper use.



PREVENT ACCIDENTAL WATER SPRAY

- To prevent accidental water spray, the wand trigger should be placed in the locked position when not in use.



KEEP HANDS AWAY

- Keep hands and other body parts away from high pressure water stream as water pressure will cause severe bodily harm.



SAFETY GLASSES

- Always wear safety glasses while operating.

DETERGENTS

- Only use recommended detergents for pressure washers. Using detergents not specifically recommended for use with pressure washers can cause damage to pump and other pressure washer components.
- **DAMAGE CAUSED TO PRESSURE WASHER UNIT BY USING NON-RECOMMENDED DETERGENT IS NOT COVERED UNDER WARRANTY.**

COLD WEATHER STARTS

- Do not operate this pressure washer in temperatures below 5°C. Operating pressure washer under the temperature of 5°C may cause damage to pump and other pressure washer parts.
- **DAMAGE TO PRESSURE WASHER UNIT BY USER MISUSE IS NOT COVERED UNDER WARRANTY.**

SAFETY FEATURES

- **Thermal Relief Valve**
Protects the pump from overheating in case nozzle becomes clogged. This system should not be abused. Make every effort to prevent the pump from overheating.
- **Low-Oil Auto Shut-Off**
This pressure washer is equipped with a low oil shut-off system. If the engine oil level goes below the recommended oil level, the pressure washer will automatically shut-off. This protects your engine and prevents operating without proper lubrication.

STORAGE

- Store the pressure washer in a well ventilated area with the fuel tank empty. Fuel should never be stored or placed near the pressure washer.
- When storing pressure washer for winter, ensure that the pressure washer is stored indoors (at room temperature) in a dry location away from any heat sources.
- If unused gas will not be used for alternative purposes immediately, ensure you use fuel stabilizer to keep the gas from breaking down.
- To protect and extend the life of your pressure washer when storing, use pump antifreeze which can be found at your local Canadian Tire store.

PREVENT PUMP DAMAGE

- Do not run the pressure washer engine for more than 5 minutes without pressing the wand trigger or damage to the pump may result.
- Never let the machine run unless connected to the water supply. Ensure water supply is running water through the pressure washer before attempting to start engine.
- Never run caustic fluids or acid through this machine.

Pressure Washer Features

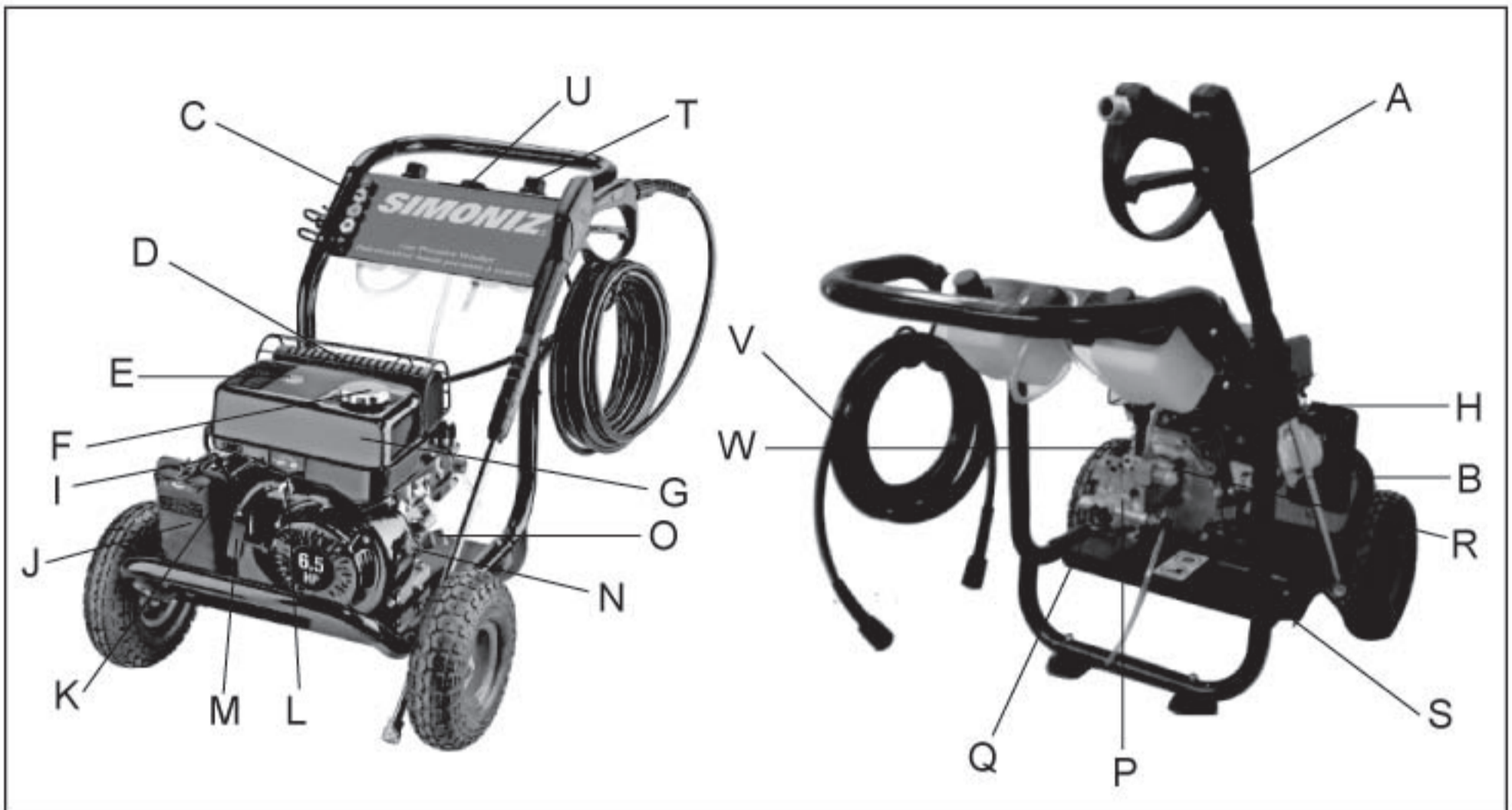

A – Trigger Locking Latch – Will prevent from mis-operating or spraying accidentally.

B – Wand – Will extend your reach for easier cleaning.

C – Spray Nozzles – 0°, 15°, 25°, 40°, soap tip; Use to apply the right pressure for each specific project

D – Muffler – Ensure you avoid contact as this will be hot during and shortly after use. Avoid resting the pressure hose on muffler.

E – Fuel Level Indicator – Unit takes unleaded gas only. DO NOT use 'old' gas.

F – Fuel Cap – Ensure cap is on tight during use.

G – Fuel Tank – Has a 4 L capacity

H – Spark Plug – Should be checked every 100 hours of operation.

I – Choke Lever – Will control incoming air.

J – Air Filter – Filter should be replaced annually to ensure optimal performance

K – Throttle Lever – This will adjust the engine speed

L – Fuel Valve – Regulates the flow of fuel to the engine. Must be fully open before starting engine.

M – Recoil Starter – This will start the engine

N – On/Off Switch – Ensure this is set to 'ON' before attempting to start engine.

O – Oil Dipstick – Ensure the unit has the proper level of oil before starting engine. Use only SAE 10W-30 oil.

P – Pump – Will increase pressure when running.

Q – Pump Inlet – Attach your garden hose here.

R – Pump outlet – Attach your pressure hose here.

S – Thermal Relief Valve – This includes a drain pipe to be used if resting water inside pump becomes too hot. This will help prevent damage to pump.

T – Detergent Tank Caps – Take these caps off to fill either detergent tank with pressure washer approved detergent.

U – Detergent Dial – Allows you to switch between different detergents without stopping.

V – Pressure Hose – Attach to pump and gun. 50' (15.2 m).

W – Pump Breather – Will prevent pressure inside pump from going too high.

ASSEMBLY & PRE-START CHECK

Before assembling or starting pressure washer, ensure entire manual has been read.

UNPACK BOX: Remove all parts from box and remove all bubble wrap and other packaging materials.

CONTENTS OF BOX:

REF	Part Description	Quantity
A	Wheel with axle	2
B	Metal pressure gun, Stainless steel wand	1
C	50 ft pressure hose	1
D	Main body of pressure washer	1
E	Pressure washer handle with 5pcs Spray nozzles	1
F	Gun Supporter Hose Supporter	1
G	Bolts (M6*40)x2, Nuts (M6)x2, Washers (φ6)x4, Manualx1, Spray tip cleanerx1, Spark plug wrenchx1, Screw driverx1, Pump BreatherX1, O-ring (2 for high pressure hose, 1 for tip quick connector), Inlet water filter	1

⚠ WARNING! Before attempting to start pressure washer, ensure you complete the following important steps.

- 1) Fill gasoline tank with Unleaded Gasoline. This is a 4-cycle engine with separate reservoirs for gas and oil. **DO NOT** use pre-mixed gas! **DO NOT** use old gas! Fuel must be purchased separately.
- 2) Fill oil tank with SAE 10W-30 oil. Running pressure washer without oil will severely damage engine which is not covered by warranty! Oil must be purchased separately.
- 3) Ensure both the pressure hose and garden hose have been correctly attached to the pressure washer pump. Ensure the water tap is on and water is running through the hose before attempting to start engine. Not doing this will damage the pump!

ASSEMBLY INSTRUCTIONS:

1. Install the wheels to the frame by first pressing its spring loaded pin (A) on wheel axle (B), then insert wheel shaft into frame and align spring loaded pin with hole in frame until the pin snaps. Repeat for the other wheel.

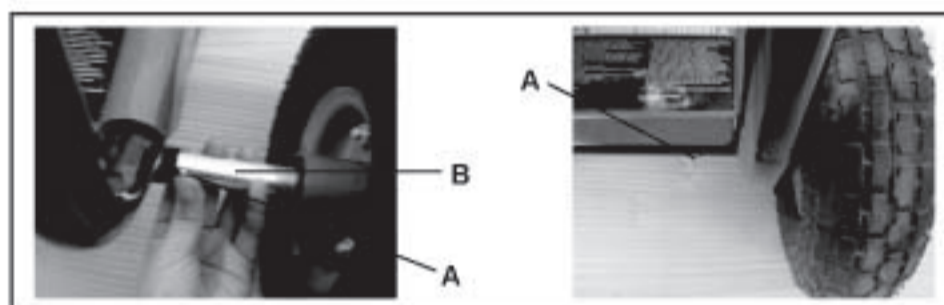
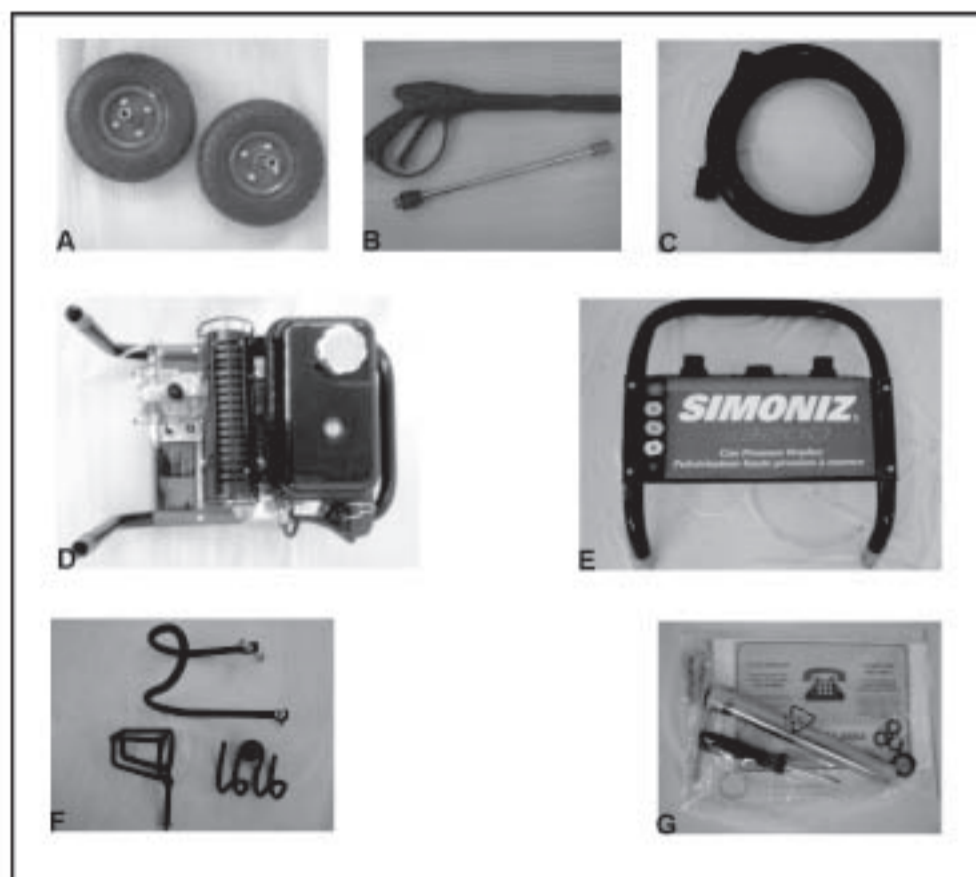

2. Install the top handle to the frame by sliding the top handle posts into the frame posts and secure them together using 2 pan head bolts, 4 washers and 2 nylon hex nuts.



3. Assemble the hose support (A) to the right side of the frame using 2 pan head bolts 4 washers and 2 nylon hex nuts.

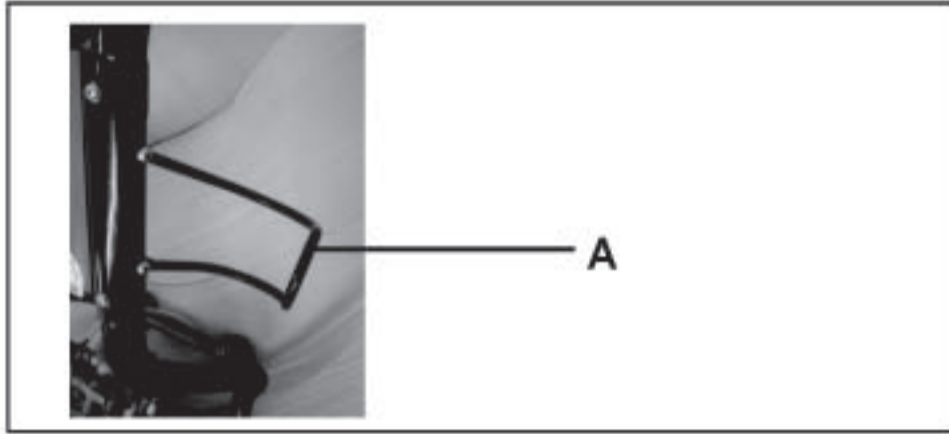

4. Assemble the wand support (A) to the left side of the frame and corner of base using 2 pan head bolts, 4 washers and 2 nylon hex nuts.

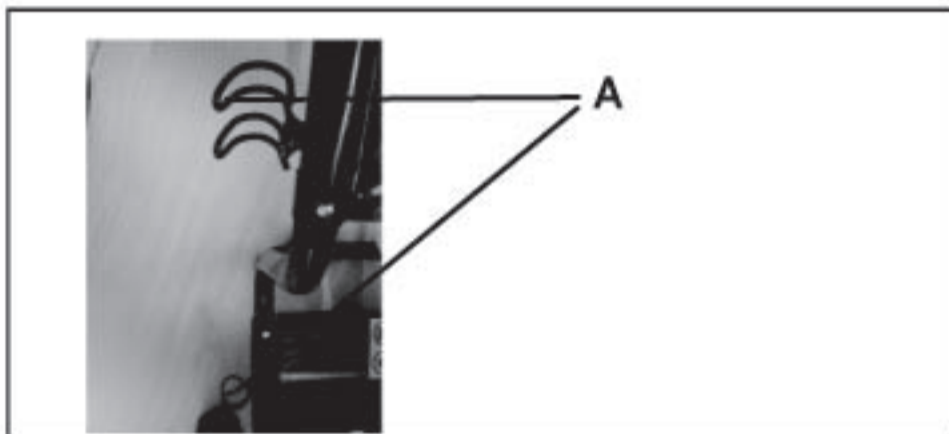

5. Insert water inlet filter (A) at pump inlet. Attach garden hose to pump inlet (B). See illustration below.

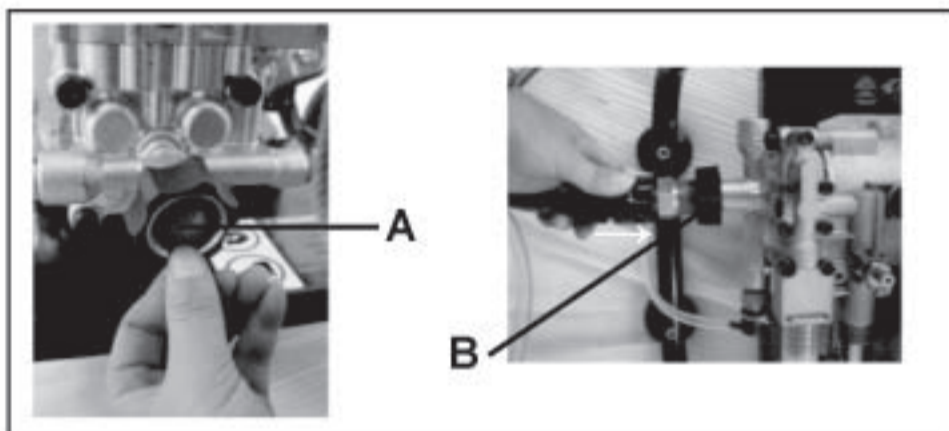

6. Assemble the stainless steel wand (A) and the metal gun (B). Pull back the rubber piece (C) to expose the threaded fitting and screw the 2 pieces together, re-position the rubber piece.

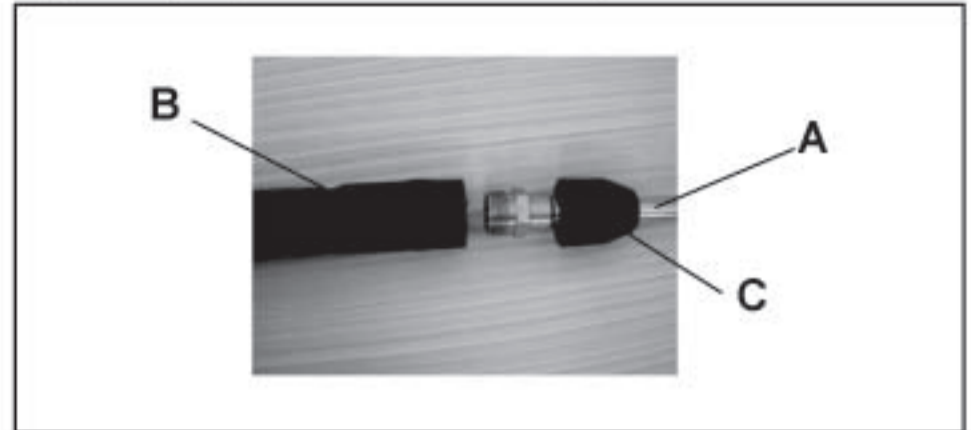

7. Next install the pressure hose to the wand (A) and install the other end of the pressure hose to the pump outlet (B) as shown below.

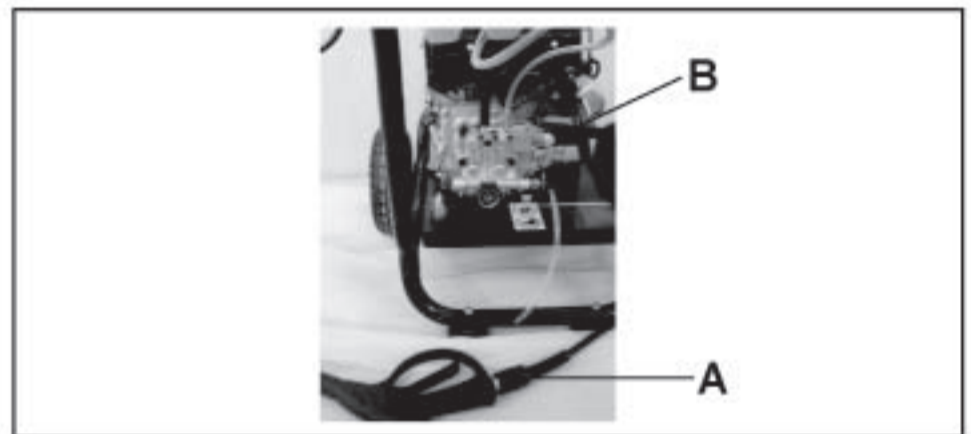

8. Then install the detergent injector tube over the detergent siphon fitting (A).

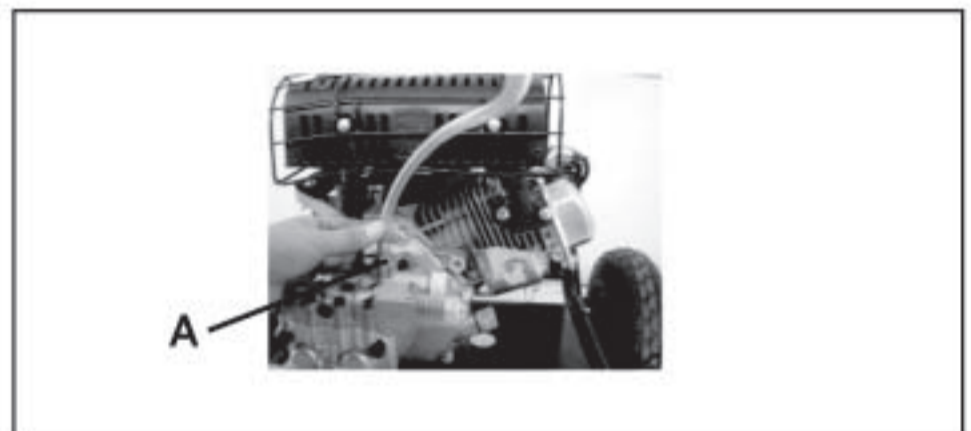

9. Screw the hex bolt (A) down by wrench, then screw pump breather (B) on by hand.

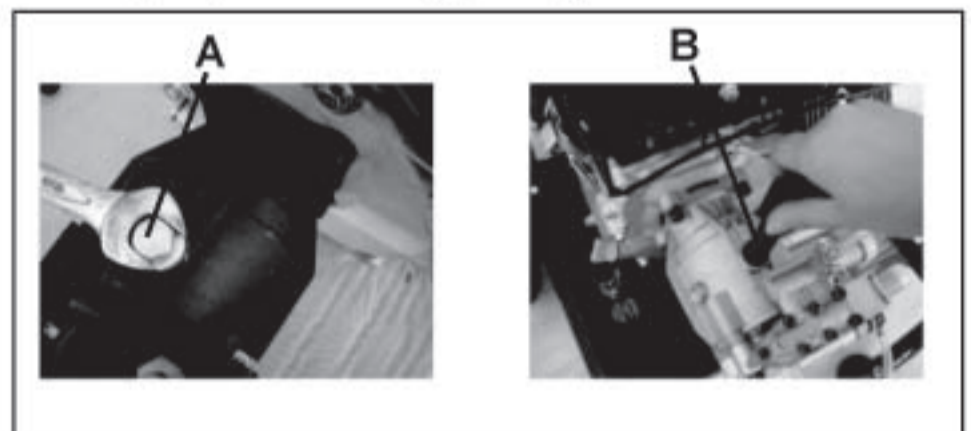

PRE-START CHECK OIL LEVEL

⚠️WARNING! Pressure washer has no oil currently in crankcase! Operating the unit without the correct amount of oil will damage the engine. Oil crankcase capacity: 0.6 L.

Always check the oil level before starting the engine, make sure the pressure washer is on a level surface before checking oil level. Always use SAE 10W-30 oil.

To Check Oil Level;

- 1) Turn the oil gauge dipstick (A) counter clockwise; remove it and clean it with a clean cloth.
- 2) Fully reinsert the oil gauge dipstick and pull it out to check the oil level.
- 3) If the oil level is halfway up the dipstick or below, refill with SAE 10W-30 oil through the dipstick hole until the oil level reaches 3/4 up the dipstick or until it reaches the bottom lip of the dipstick hole as shown in illustration to the right.
- 4) Re-position the oil gauge dipstick and tighten it by turning clockwise.

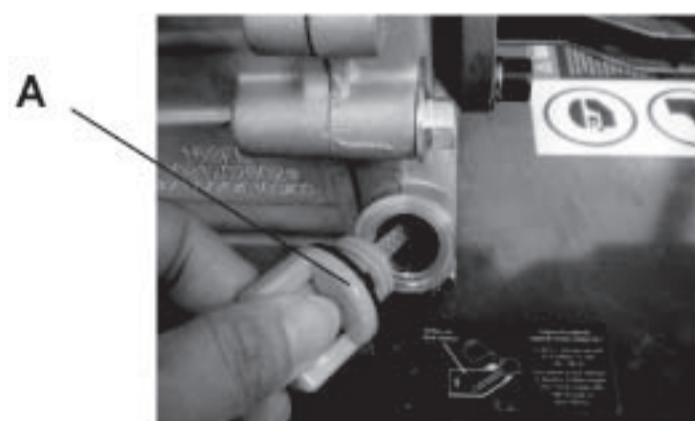

PRE-START CHECK FUEL LEVEL

⚠️WARNING! Make sure there is enough fuel in the fuel tank before operating.

Check the fuel level indicator window(A), if the red float gauge is all the way up, it is not necessary to add fuel. If the red float gauge is not, or barely, visible, it is necessary to add fuel.

- 1) If it is necessary to add fuel, first make sure the engine is OFF, and then remove the fuel cap (B) by turning it counter clockwise.
- 2) When refuelling, make sure the fuel filter (C) is in place and keep in mind all safety precautions.
- 3) Use clean unleaded gasoline with a minimum of 87 octane. **DO NOT** use old gas. **DO NOT** mix oil with gasoline. Fuel tank capacity: 4.0 Litres.

*** This is a 4-cycle engine and does not require a gas/oil mixture. There is a separate reservoir for gas and a separate reservoir for oil.

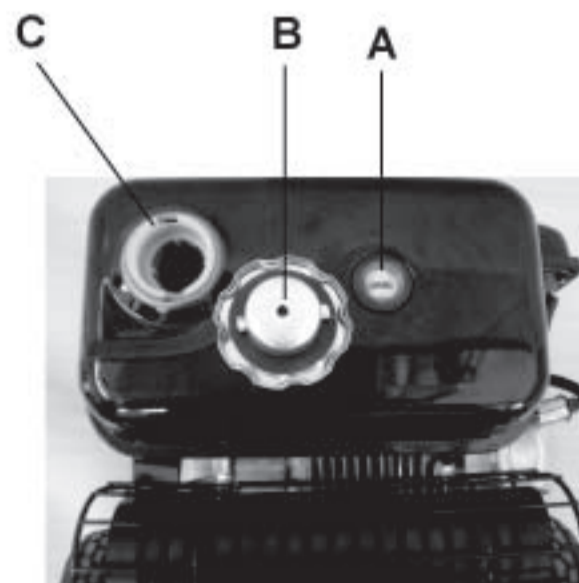

PRE-START CHECK AIR FILTER

⚠️WARNING! The air filter should be checked after prolonged storage, the following steps should be done when checking the air filter. It is recommended to replace the air filter once every Spring.

- 1) Snap the top and bottom clips(A) backwards and remove the air filter cover (B).
- 2) Remove the air filter(C), wash filter in kerosene, squeeze kerosene out, soak filter in engine oil and squeeze engine oil out.
- 3) Replace filter and replace the air filter cover.







START-UP PROCEDURES & OPERATION

START-UP PROCEDURES

Follow these instructions to safely start your pressure washer:

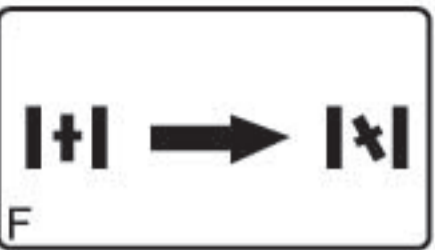
- 1) Check engine oil level; fill to recommended level if necessary. Check gasoline level, fill if necessary. Fig.A
- 2) Connect garden hose to the pump and TURN WATER ON. The water supply must provide a minimum of 4 GPM at 20 PSI or the pump may be damaged. Fig.B
- 3) Squeeze gun trigger. This will allow air to escape from the hose in order to prime the pump. Squeeze trigger until there is a steady flow of water. Fig.C
- 4) Turn engine switch to the "On" position. Fig.D
- 5) Open fuel valve ("On" position). Fig.E



<p>6) Close the Choke lever by moving the lever towards the left. Also move the throttle lever to its maximum setting (towards the left). Fig.F</p>	 
<p>7) Locate recoil cord and pull slowly until resistance is felt. At this point, pull rapidly to start engine. <u>Repeat if necessary.</u> Fig.G</p>	
<p>8) Once engine starts, open choke lever by moving the lever towards the right. Fig.H</p>	 
<p>9) If motor fails to start, repeat steps 3-10. Fig.I</p>	
<p>10) If you have problems starting the pressure washer, call the Simoniz toll-free number and one of our customer service representatives will be glad to assist you.</p>	

OPERATION: SPRAY NOZZLE USAGE

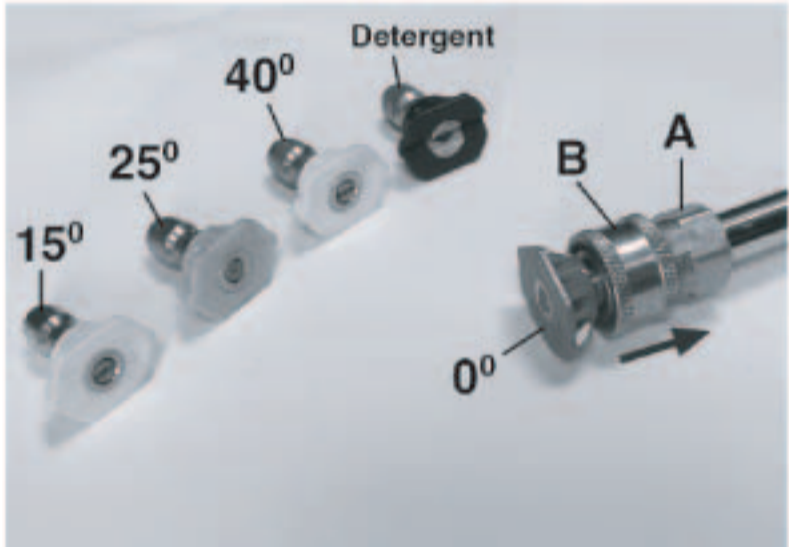
<ul style="list-style-type: none"> • This pressure washer comes with a stainless steel wand, its tip has a quick connect coupler(A) to fit different nozzles. • The spray pattern is adjusted by installing the appropriate spray pattern nozzle to the quick connect coupler. Five nozzles included, 0°, 15°, 25°, 40° and a detergent nozzle. • To install a nozzle to the quick connect coupler, pull the coupler ring(B) backwards and insert the desired nozzle, release the coupler ring to lock it in place. 	
------------------------------------------------------------------------------------------------------------------------------------------------------------------------------------------------------------------------------------------------------------------------------------------------------------------------------------------------------------------------------------------------------------------------------------------------------------------------------------------------------------------------------------------------------	---------------------------------------------------------------------------------------

NOZZLE USAGE:

<ul style="list-style-type: none"> • 0° (red) - Thin and powerful stream of water for difficult stains and debris removal. • 15° (yellow) - Thin angled spray for focused cleaning. • 25° (green) - Medium angled spray for focused cleaning. • 40° (white) - Large fan pattern for wider cleaning applications. • Detergent (black) - This nozzle must be used in conjunction with a cleaning detergent at low pressure. Only use this nozzle when using a detergent or cleaning solution. 	
-----------------------------------------------------------------------------------------------------------------------------------------------------------------------------------------------------------------------------------------------------------------------------------------------------------------------------------------------------------------------------------------------------------------------------------------------------------------------------------------------------------------------------------------------------------------------------------	---------------------------------------------------------------------------------------

ADJUSTING WATER PRESSURE:

- The water pressure is regulated by the throttle lever. (A)
- Moving the throttle lever towards the left will increase the engine speed and thus increasing the water pressure.
- Moving the throttle lever towards the right will decrease the engine speed and thus decreasing the water pressure.

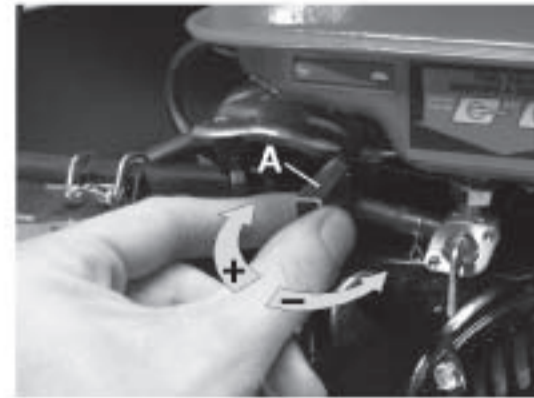

DETERGENT INJECTOR (LOW PRESSURE):

- This pressure washer is intended for use with pressure washer detergents only.
- Do not use powdered soaps which clog the injection system.
- Follow the detergent manufacturer's directions or call the Simoniz toll-free number if you have any questions or concerns.

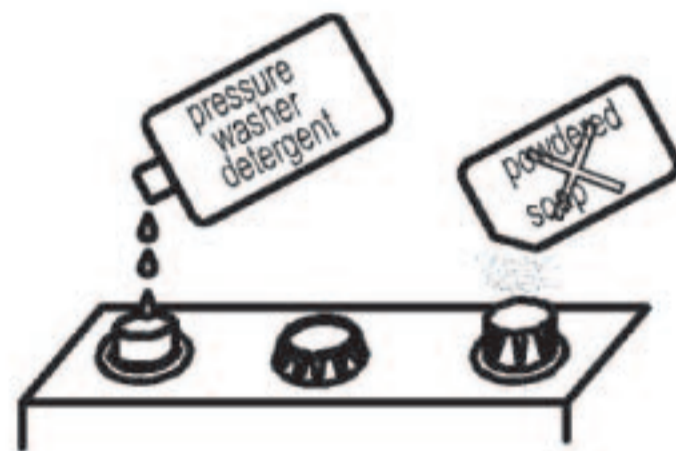

HOW TO USE DETERGENT WITH PRESSURE WASHER:

- 1) Ensure detergent siphon tubes are set up correctly. You may want to refer to assembly instruction #9 on page 10 to verify that siphon tubes are set up properly.
- 2) Pour the two kinds of detergents into the detergent tanks. It is recommended to have one detergent tank filled with All-Purpose detergent, and the other filled with a more specific cleaning detergent.
- 3) The indicator on the detergent dial shows the amount and the consumption of detergent. Fig.A
- 4) When using a detergent, the stainless steel wand must be fitted with the detergent nozzle (black). See 'OPERATION SPRAY NOZZLE USAGE' on page 14 for instructions on how to connect detergent nozzle to wand. Fig.B
- 5) If the throttle lever is not in the fast position, the injection of the detergent may be decreased or stopped completely, in this case, move the throttle lever towards the left to increase engine speed and pressure.

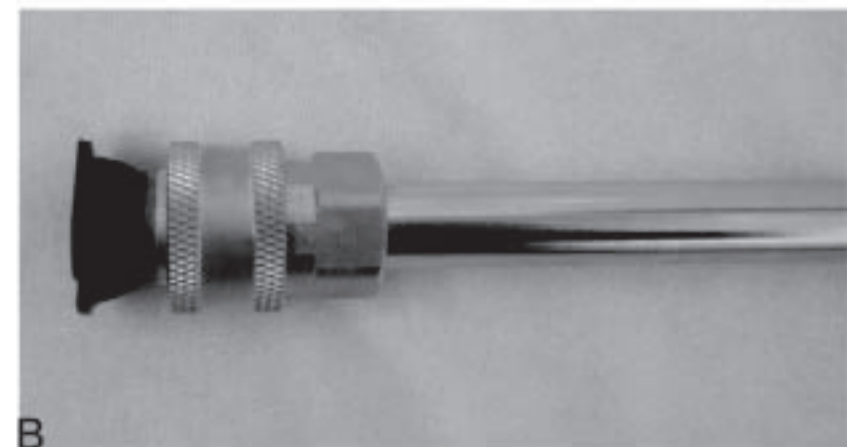

- ⚠ **Important Note:** When you have finished using the detergent injector system, remove the injector filter from the detergent container and place it in a different larger container containing only clean water and let the pressure washer run until you no longer notice detergent coming out of the wand. This will prevent detergent from gumming up the wand and reducing pressure for next use.

USING THE PRESSURE WASHER TO CLEAN:

- Some cleaning jobs can be completed by using only water, but for most, it is advantageous to use a detergent to penetrate and remove the dirt more effectively. When using pressure washer approved detergent, make sure the surface to clean is dry. Wetting the surface first is not recommended; it will dilute the detergent and will reduce the cleaning effectiveness.
- Avoid hot surfaces or direct sunlight; this will minimize the chances of the detergent damaging the painted surface.
- **DO NOT** let the detergent dry or it may damage the painted surface. Allow the detergent to remain on the surface for a short time before rinsing with clean water under high pressure.
- Position the tip of the wand 6-8" (15-20 cm) away from the surface to clean at a 45° angle.

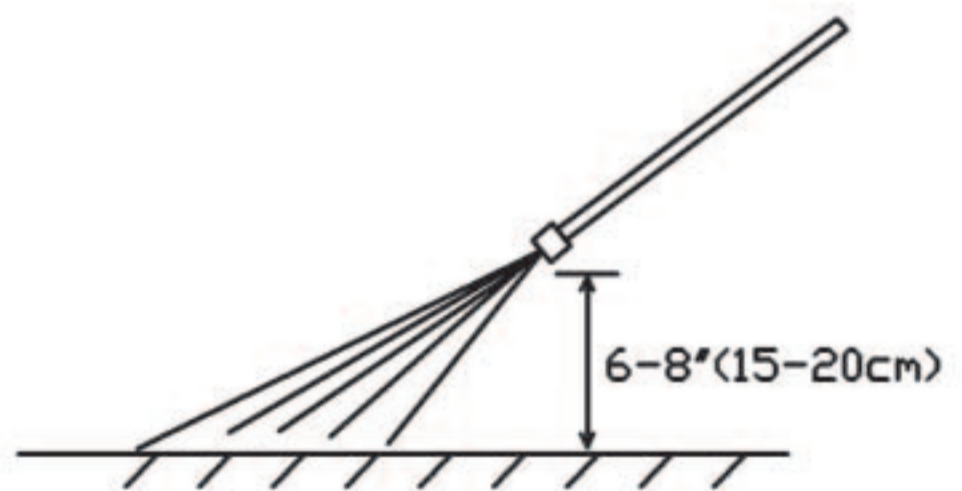

TROUBLESHOOTING

PROBLEM	CAUSE	CORRECTION
Engine will not start (or stops while operating)	<ol style="list-style-type: none"> 1. Low-oil shutdown 2. Engine switch not in "ON" position. 3. Pressure built up in the hose 	<ol style="list-style-type: none"> 1. Fill engine with SAE 10 W-30 oil 2. Turn switch "ON" 3. Squeeze trigger while starting
If engine sounds abnormally, it could be overloaded.	<ol style="list-style-type: none"> 1. Nozzle partially blocked 2. Excessive pressure 	<ol style="list-style-type: none"> 1. Clean nozzle 2. Shorten the spring coil of the reflux valve
Engine is running but pump won't build maximum pressure or has irregular pressure	<ol style="list-style-type: none"> 1. Faucet closed 2. Unit has been stored in freezing temperatures 3. Inadequate water supply 4. Water inlet screen clogged 5. Kink in garden hose 6. Wand tip worn or damaged 7. Air in pump 8. Engine speed not set to maximum position 	<ol style="list-style-type: none"> 1. Open faucet 2. Thaw out unit completely including hose, gun and wand, if the machine still doesn't work, call the Simoniz toll-free number. 3. Provide a minimum of 4 GPM at 20 PSI 4. Clean screen 5. Straighten garden hose 6. Replace wand 7. Let it run with gun open and wand removed until steady stream of water is released 8. Set throttle to maximum position
No intake of chemicals	<ol style="list-style-type: none"> 1. Injection tube not securely inserted into unit 2. Tube cracked or split 3. Wrong nozzle 4. Injector dial turned off 5. Injection tube strainer clogged 6. Nozzle blocked 7. Clogged chemicals injector 	<ol style="list-style-type: none"> 1. Push firmly into injector fitting 2. Replace tube 3. Switch to low pressure nozzle 4. Turn collar counter-clockwise 5. Clean strainer 6. Clean nozzle 7. Dissolve by running warm water
Trigger will not move	<ol style="list-style-type: none"> 1. Gun safety lock engaged 	<ol style="list-style-type: none"> 1. Release safety lock
Water in crankcase	<ol style="list-style-type: none"> 1. High humidity 2. Worn seals 	<ol style="list-style-type: none"> 1. Change oil more frequently 2. Change the oil seals
Noisy operation	<ol style="list-style-type: none"> 1. Worn bearings 2. Air mixed with water 	<ol style="list-style-type: none"> 1. Change the bearing 2. Check inlet lines for restrictions and/or proper sizing
High crankcase temperatures	<ol style="list-style-type: none"> 1. Wrong grade of oil 2. Improper amount of oil in crankcase 	<ol style="list-style-type: none"> 1. Use SAE 10W-30 oil 2. Adjust oil level to proper amount
Rough/pulsating operating with pressure drop	<ol style="list-style-type: none"> 1. Inlet restriction 2. Air mixed with water 	<ol style="list-style-type: none"> 1. Check system for stoppages, air leaks, correctly sized inlet, plumbing to pump 2. Check inlet lines for restrictions and/or proper sizing

MAINTENANCE

WATER INLET FILTER:

- This pressure washer is equipped with a water inlet filter(A).
- This water filter must be kept clean at all times or else it will restrict the water flow to the pressure washer and may damage the pump.
- Remove and clean water filter.
- **DO NOT** operate this pressure washer without the water inlet filter in place as deposits could build up internally and affect the functioning of the unit.

*** See in-store for replacement filters.

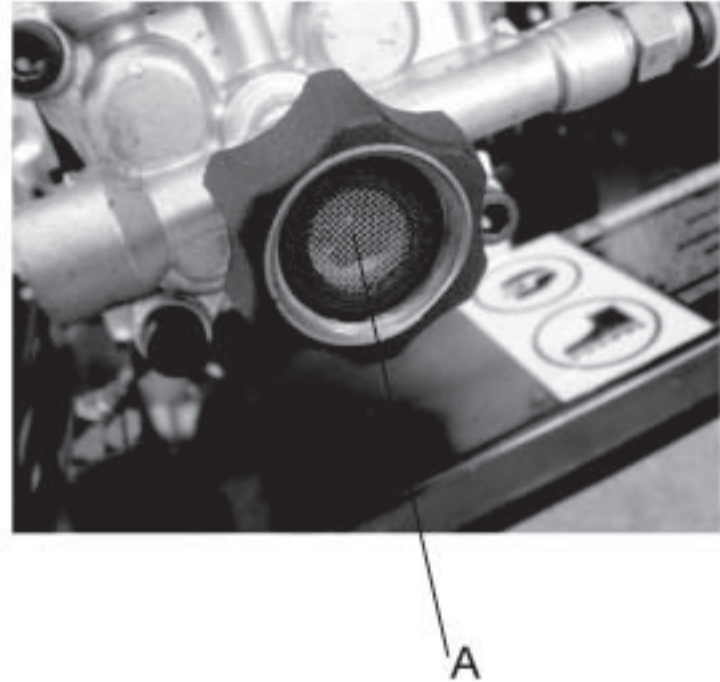

ENGINE MAINTENANCE:

Engine Oil Replacement

- Engine oil should be replaced after the first 20 hours of operation or after the first month of use.
- It should be replaced every 100 hours or 6 months.
- To replace engine oil; Loosen the oil gauge dipstick(A). Place an oil pan underneath drain hex bolt, remove hex bolt and drain oil. Once all the oil has completely drained, retighten the hex bolt(B).

Recommended Engine Oil

- It is recommended to use SAE10W-30 4-stroke gasoline engine oil.
- Fill with clean engine oil through the oil gauge dipstick hole to recommended level.

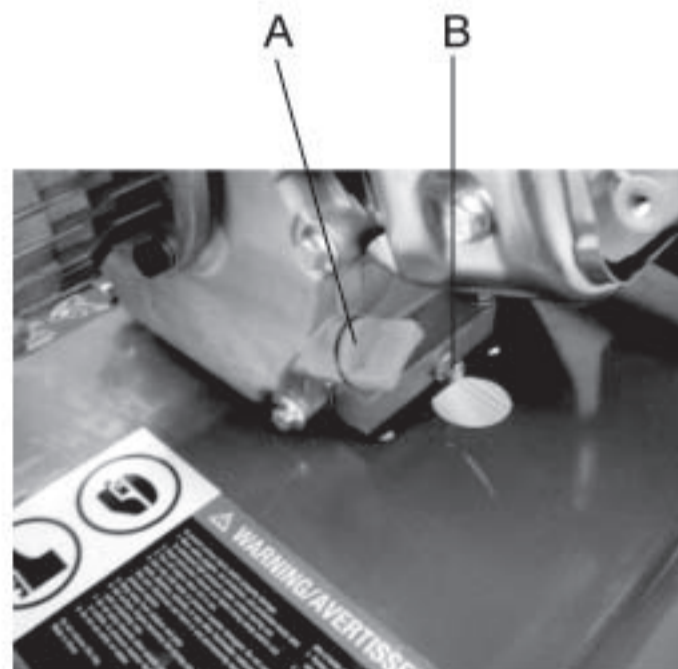

Inspecting, Replacing or Cleaning Spark Plug

- The spark plug should be checked every 100 hours of operation or every 6 months.

To replace or clean spark plug:

- 1) Dismantle the spark plug wire(A) by pulling it off the spark plug(B). Using the supplied spark plug wrench, undo the spark plug by turning counter clockwise.
- 2) Check to see if there is carbon sediment build-up, if so, remove it. If the carbon sediment is excessive, replace the spark plug.
- 3) Measure the electrodes clearance using a feeler gauge. The spark plug electrode clearance should be between 0.7-0.8 mm. If the clearance exceeds 0.8 mm, replace the spark plug. The original spark plug supplied is an LG F7RTC, you can replace it with an NGK BP6ES spark plug or equivalent.
- 4) Reinstall spark plug in the reverse order.

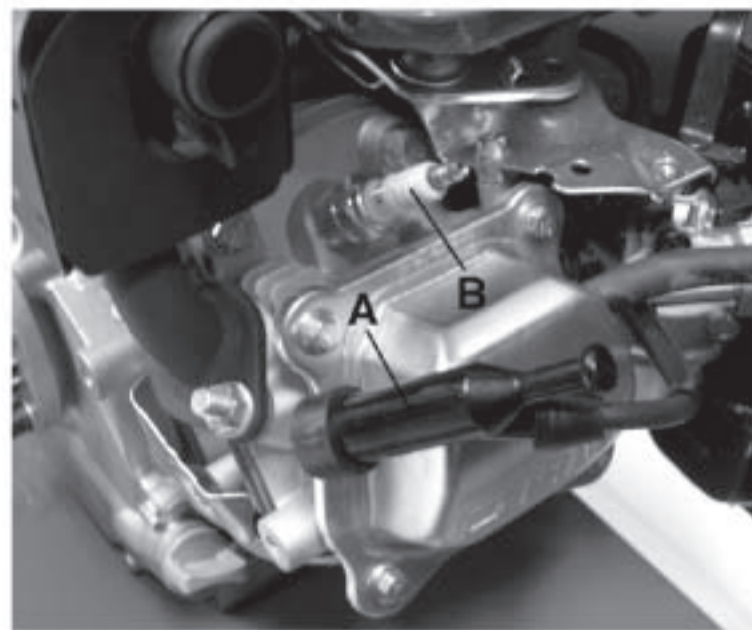

PRESSURE WASHER STORAGE:

-If you plan on storing your pressure washer for an extended period of time, the following steps should be followed:

- 1) Add fuel stabilizer to fuel tank to minimize the formation of fuel gum deposits during storage.
- 2) Run engine at least 5 minutes after adding stabilizer to allow it to enter the fuel system.
NOTE: If a fuel stabilizer is not used, all gasoline must be drained from the tank and carburetor to prevent gum deposits from forming on these parts and causing possible malfunction of the engine (see instructions on draining fuel below).
- 3) Drain engine oil from engine as described in "Engine Oil Replacement"
- 4) Pour approximately one teaspoon of engine oil through the spark plug hole and pull the recoil starter slowly until you feel increased pressure which indicates the piston is on its

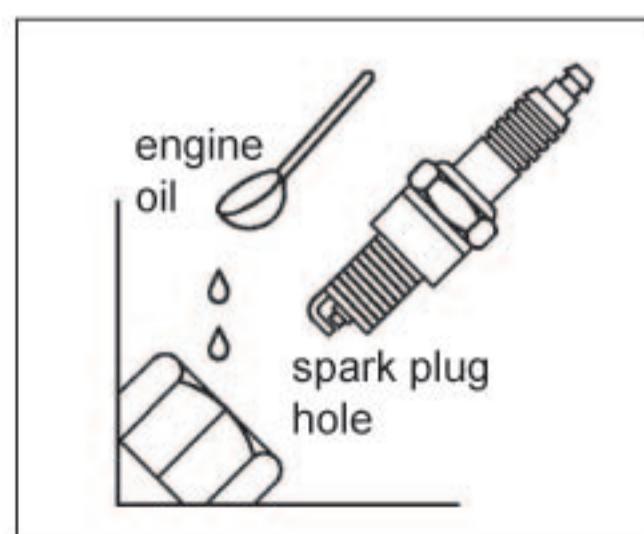
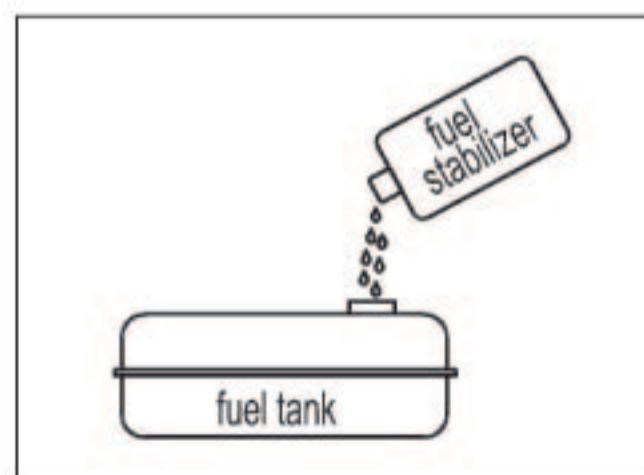

compression stroke and leave it in this position. This closes both the intake and exhaust valves to prevent the inside of the cylinder from rusting.

5) Use pressure washer antifreeze to ensure that your pump will not freeze during the winter. See instructions below on "Preventing Freezing Damage".

6) Cover the pressure washer and store it in a clean, well ventilated and dry place. Ensure storage area is at room temperature.

*** See in-store to purchase fuel stabilizer or antifreeze

-If you wish to drain the fuel instead of adding fuel stabilizer, please follow these steps:

- 1) Turn fuel shut-off valve to the "OFF" position, remove drain hex. Bolt(A) from the carburetor.(B)
- 2) Now turn fuel shut-off valve to the "ON" position and drain the fuel from the tank, carburetor and hose.
- 3) Reposition the carburetor drain hex bolt once the fuel is completely drained.

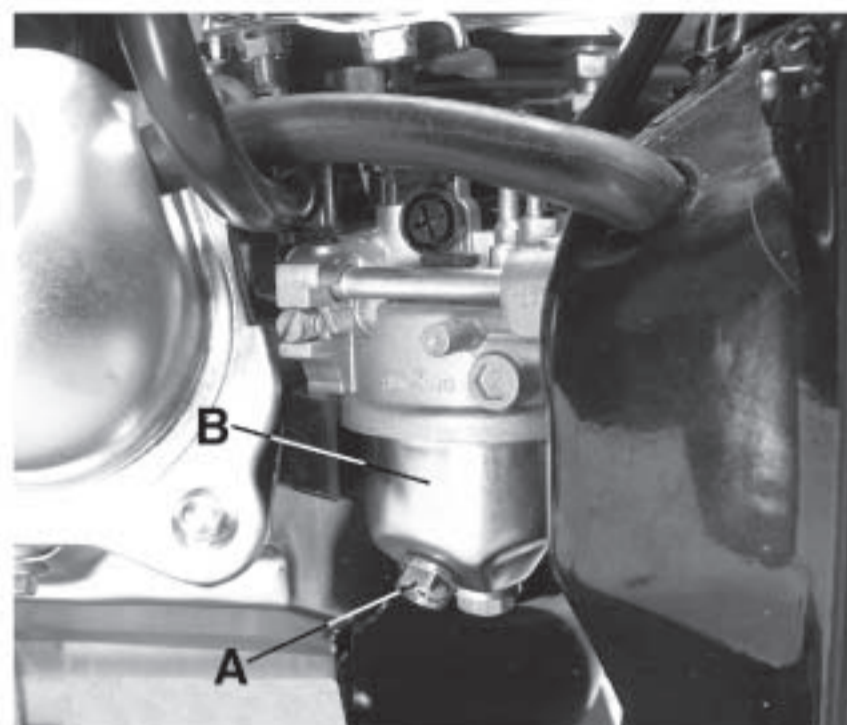

PREVENTING FREEZING DAMAGE:

- If your pressure washer is subjected to freezing temperatures, damage could occur. This type of damage **is not covered under warranty**. To avoid possible damage, a small amount of antifreeze can be used.
- Place the unit on its side with the water inlet facing upwards, pour 1/4 cup of antifreeze into the water inlet.
- Disconnect spark plug wire, and then pull recoil starter several times to circulate the antifreeze in the pump system. Reconnect spark plug wire.
- It is also important to make sure the wand and all hoses are disconnected and drained of all water or they may burst.
- When taking pressure washer out of storage, run water through the system until it runs clear.

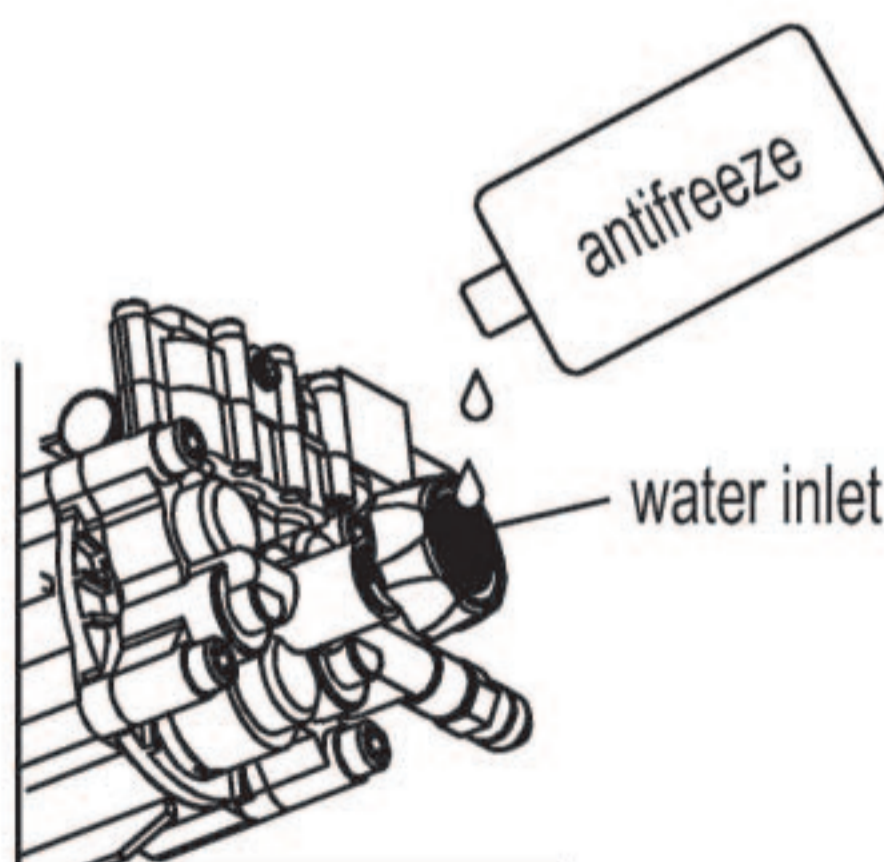
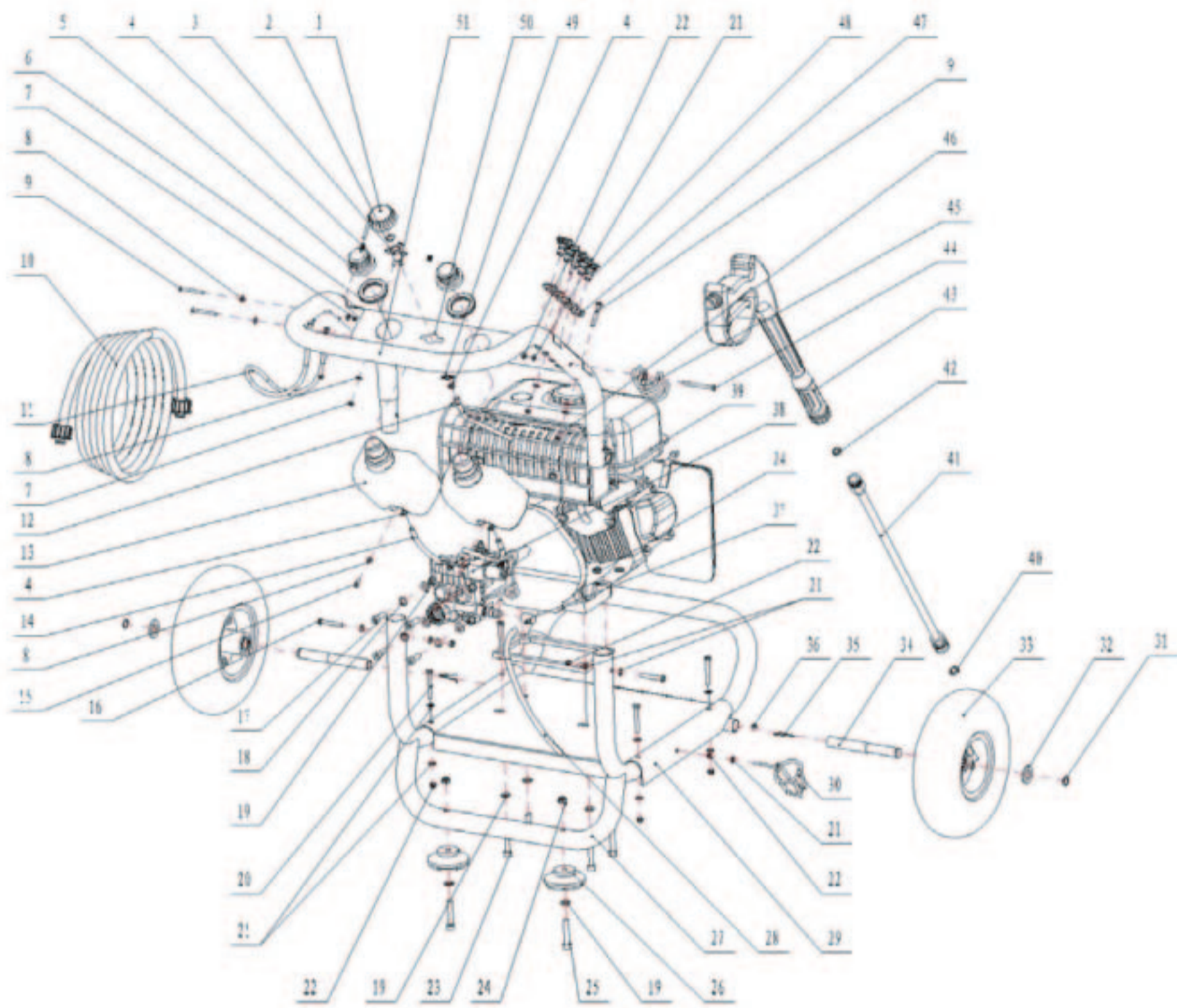

DIAGRAM AND PARTS LIST



Ref No	DESCRIPTION	QTY	Ref No	DESCRIPTION	QTY
1	Detergent bottle switch knob	1	29	Deck	1
2	Detergent bottle switch seal ring	1	30	Gun tip holder	1
3	Detergent bottle switch	1	31	Circlip ϕ 16	2
4	Spring Lock	5	32	Washer ϕ 16	2
5	Detergent bottle cap	2	33	10" (25.4 cm) wheel	2
6	Detergent bottle gasket	2	34	Wheel shaft	2
7	Locknut M5	6	35	Spring wire	2
8	Washer ϕ 5	10	36	Circlip	2
9	Cross bolt M5*45	6	37	Thermal relief cap	1
10	50' high pressure hose	1	38	High pressure pump	1
11	Hose hook	1	39	Gasoline engine	1
12	Injection hose (long)	1	40	O ring for wand	1
13	Detergent bottle	2	41	Wand	1
14	Injection hose (short)	2	42	O ring for gun	1
15	Cross bolt M5*12	2	43	Gun	1
16	Cross bolt M6*40	2	44	Inner hex bolt M6*60	1
17	Inner hex bolt M8*25	4	45	Gun holder	1
18	Spring gasket ϕ 8	4	46	Muffler shade	1
19	Washer ϕ 8	14	47	Nozzle grommet	5
20	Cross bolt M6*45	4	48	Nozzle	5
21	Washer ϕ 6	14	48-1	0° nozzle (red)	1
22	Locknut M6	8	48-2	15° nozzle (yellow)	1
23	Inner hex bolt M8*40	4	48-3	25° nozzle (green)	1
24	Locknut M8	6	48-4	40° nozzle (white)	1
25	Inner hex bolt M8*45	2	48-5	Detergent nozzle (black)	1
26	Rubber foot	2	49	Detergent bottle switch nut	1
27	Frame	1	50	Panel	1
28	Drain pipe	1	51	Handle	1
#	Owner's Manual	1			

"#" Indicates a non-illustrated part.

LIMITED WARRANTY

This Simoniz® product has a limited 30-day over-the-counter replacement warranty, a 2-year repair warranty on main unit against defects in manufacturing workmanship and materials, and a 90-day warranty on included accessories. All warranty claims must be accompanied by proof of purchase.

Subject to the conditions and limitations described below, this product, if returned to us with proof of purchase within the stated warranty period and if covered under this warranty, will be repaired or replaced (with the same model, or one of equal value or specification), at our option. We will bear the cost of any repair or replacement and any costs of labour relating thereto.

These warranties are subject to the following conditions and limitations:

- a) a bill of sale verifying the purchase and purchase date must be provided;
- b) this warranty will not apply to any product or part thereof which is worn or broken or which has become inoperative due to abuse, misuse, accidental damage, neglect or lack of proper installation, operation or maintenance (as outlined in the applicable owner's manual or operating instructions) or which is being used for industrial, professional, commercial or rental purposes;
- c) this warranty will not apply to normal wear and tear or to expendable parts or accessories that may be supplied with the product that are expected to become inoperative or unusable after a reasonable period of use;
- d) this warranty will not apply to routine maintenance and consumable items such as, but not limited to, fuel, lubricants, vacuum bags, blades, belts, sandpaper, bits, fluids, tune-ups or adjustments;
- e) this warranty will not apply where damage is caused by repairs made or attempted by others (i.e. persons not authorized by the manufacturer);
- f) this warranty will not apply to any product that was sold to the original purchaser as a reconditioned or refurbished product (unless otherwise specified in writing);
- g) this warranty will not apply to any product or part thereof if any part from another manufacturer is installed therein or any repairs or alterations have been made or attempted by unauthorized persons;
- h) this warranty will not apply to normal deterioration of the exterior finish, such as, but not limited to, scratches, dents, paint chips, or to any corrosion or discolouring by heat, abrasive and chemical cleaners; and
- i) this warranty will not apply to component parts sold by and identified as the product of another company, which shall be covered under the product manufacturer's warranty, if any.

Additional Limitations

This warranty applies only to the original purchaser and may not be transferred. Neither the retailer nor the manufacturer shall be liable for any other expense, loss or damage, including, without limitation, any indirect, incidental, consequential or exemplary damages arising in connection with the sale, use or inability to use this product.

Notice to Consumer

This warranty gives you specific legal rights, and you may have other rights, which may vary from province to province. The provisions contained in this warranty are not intended to limit, modify, take away from, disclaim or exclude any statutory warranties set forth in any applicable provincial or federal legislation.

Imported by Trileaf Distribution Trifeuil Toronto, Canada M4S 2B8